



Alumil
Building excellence every day

Alumil  **SUPREME**
S650 PHOS



CONTENTS

SUPREME S650 PHOS

DESIGN PHILOSOPHY & CHARACTERISTICS	4
SENSE OF FREEDOM	8
ATTENTION TO DETAIL	10
ATTENTION TO SAFETY	13
SECTIONS	14

SUPREME S650 ECLIPSE

THE ABSOLUTE MINIMAL DESIGN	28
SECTIONS	32

SUPREME S650 E-MOTION

FUNCTIONALITY, CREDIBILITY & COMFORT	34
--------------------------------------	----

SECTIONS	38
INSTALLATION	42
APPLICATIONS	48
TABLE OF PERFORMANCE	50

REFERENCE PROJECTS

PRIVATE RESIDENCES, VILLAS, RESORTS...	52
--	----



SUPREME S650 PHOS
is the ideal choice for sliding
windows with wide glazing surfaces
mounted in aluminium frames
that are totally flush
to the ceiling and the floor.

PHOS means **LIGHT**

*"Architecture is the learned game, correct and magnificent,
of forms assembled in the light."*

Bring Freedom

Inside

Alumil SUPREME
S650 PHOS

DESIGN PHILOSOPHY

CHARACTERISTICS

Alumil's sliding
thermal insulating system
SUPREME S650 PHOS...

Is the ideal solution for projects
requiring wide spans with **minimal
aluminium site lines.**

Massive yet elegant glazing surfaces

- All the aluminum profiles are totally concealed in wall so as to maximize natural light.
- Only 25 mm visible aluminium face width at the interlocking profile.
- Extra concealed profiles available for water drainage.
- Stainless steel rollers for smooth sliding & maximum functionality with high resistance to corrosion.
- Alternative version for top-mounted installation.

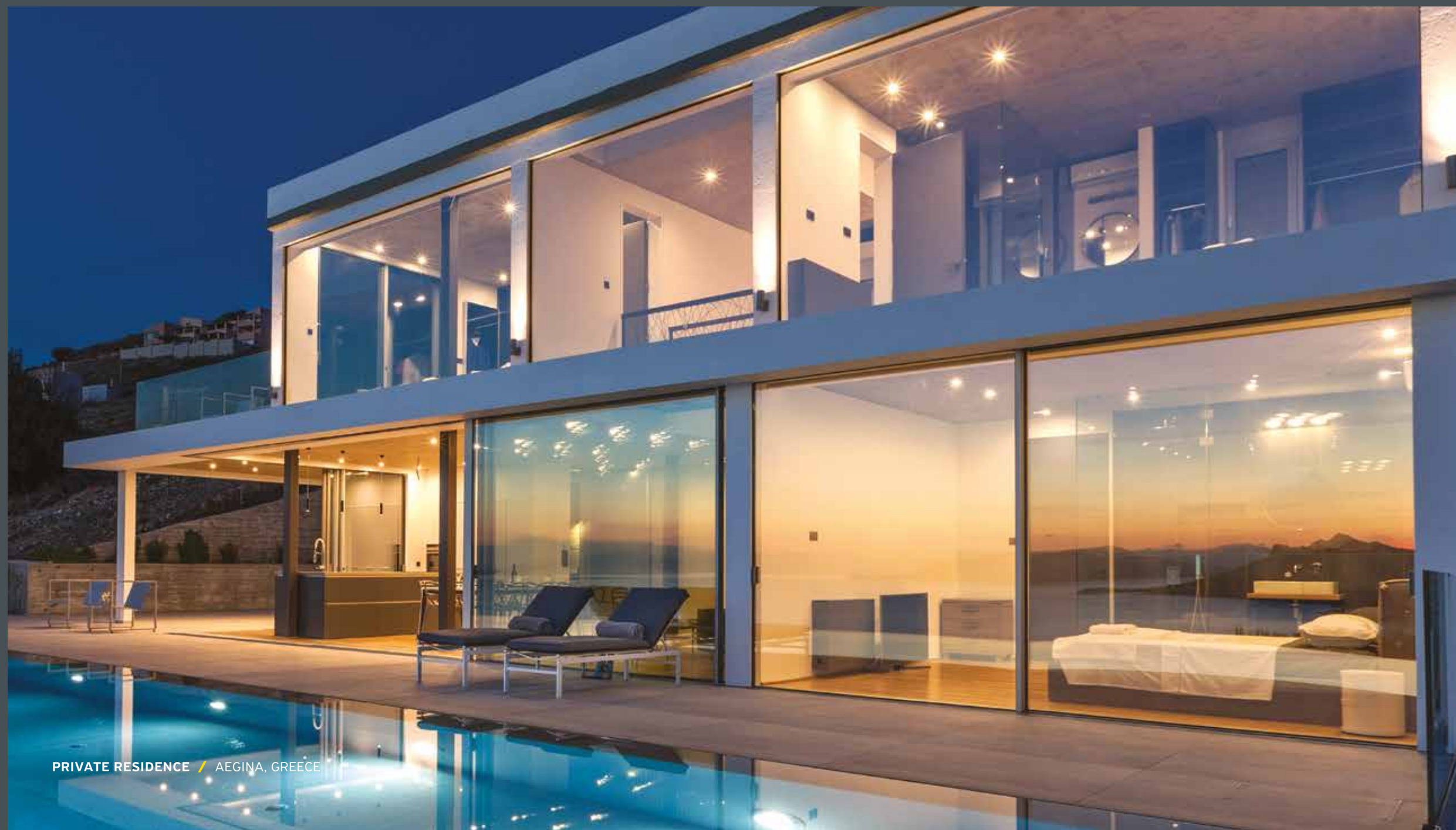

Alumil SUPREME
S650 PHOS

TECHNICAL

CHARACTERISTICS

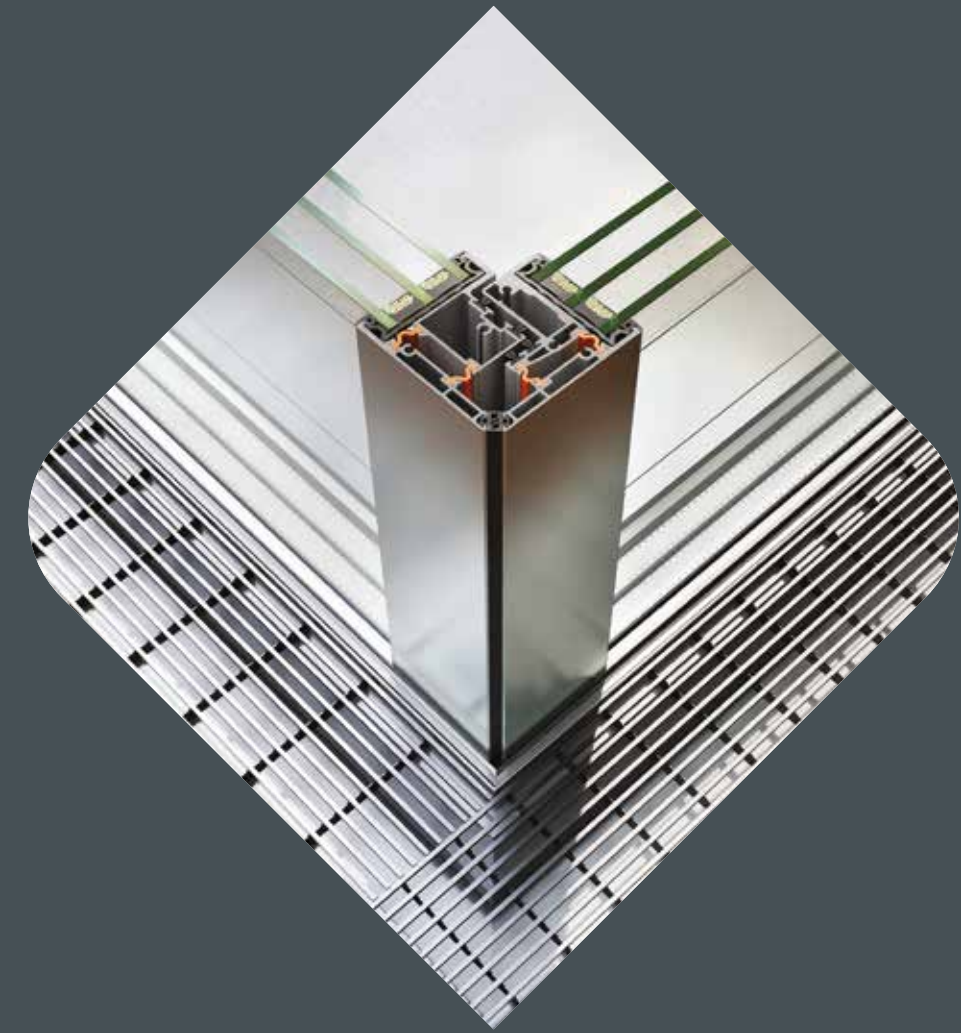

VISIBLE ALUMINIUM FACE WIDTH

CONCEALED PROFILES

FRAME HEIGHT

35 / 59 mm

FRAME WIDTH

164 mm

SASH HEIGHTS

22 / 32 mm

SASH WIDTH

62 mm

INTERLOCKING PROFILE WIDTH

25 mm

SASH WEIGHT

1000 Kg

GLAZING

36 / 46 mm

INSULATION

POLYAMIDES, PVC

The limits between interior and exterior
are eliminated as the only aluminium width is

The system's main advantage is the improvement of living conditions by **maximizing the natural lighting and minimizing the visible aluminum face width**, which makes the residents feel closer to the external environment and increases their sense of freedom.

25mm at the interlocking profile.



SUPREME S650 PHOS offers a unique combination of **elegance** and **functionality**, satisfying even the most demanding requirements.

ITS MINIMAL DESIGN ALONG WITH THE WIDE GLAZING SURFACES ENHANCE **MAXIMUM VISIBILITY** AND **NATURAL LIGHT** BY USING TOTALLY CONCEALED PROFILES INTO THE WALLS, THE FLOOR AND THE CEILING.

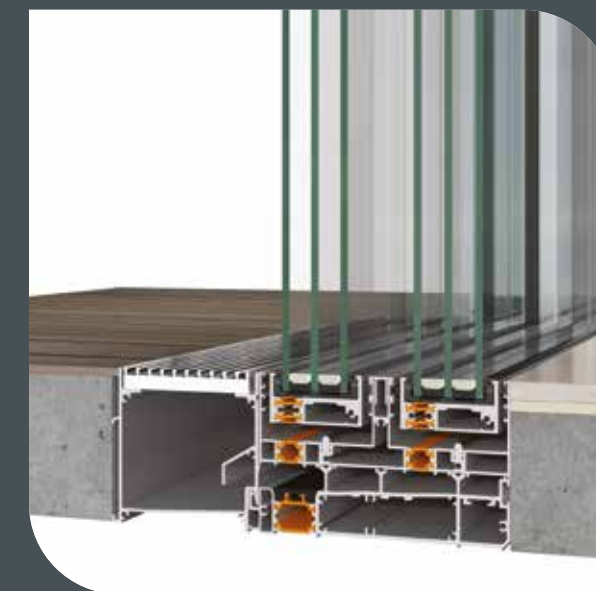

ALTERNATIVE VERSION FOR TOP-MOUNTED INSTALLATION WITH A LOW THRESHOLD, a flat track that is addressing safety issues for easy and safe access to children, elders and people with special needs. A more flexible solution ideal for renovations with innovative water drainage.

Alumil SUPREME
S650 PHOS

ATTENTION

TO SAFETY

ROLLERS

Stainless steel rollers ideal for seaside projects. For heavy duty constructions up to **1000 Kg** per sash, offering high functionality & smooth gliding of the sashes.

CERTIFIED PERFORMANCES TESTED ACCORDING EN 13126-1 AND EN 1670 FOR:

- CORROSION RESISTANCE
- DURABILITY
- STATIC LOAD
- HARDNESS

LOCKING SYSTEM

CERTIFIED PERFORMANCES TESTED ACCORDING EN 13126-1 AND EN 1670 FOR:

- MULTIPLE POINT LOCKING
- TOP - BOTTOM WITH ROD & ON THE VERTICAL FIXED FRAME WITH BOLTS AND STRIKERS

HANDLES

Branded handles with **ALUMIL** unique design offer high security as they are lockable with key placed on the handle level. In addition, they are very easy to install after transportation on site and can be easily removed for maintenance.



2 Sashes / 2 Track

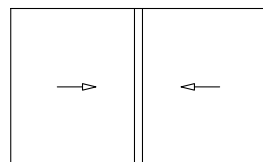

The innovative design of the concealed water drainage system offers excellent performance even under adverse weather conditions.

Specially perforated profiles and accessories, assembled together, facilitate the water outflow.

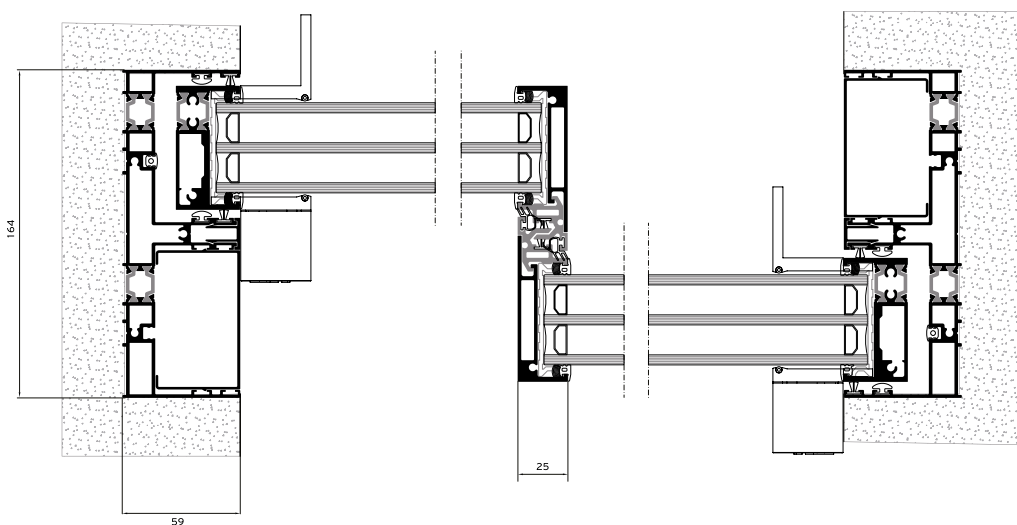
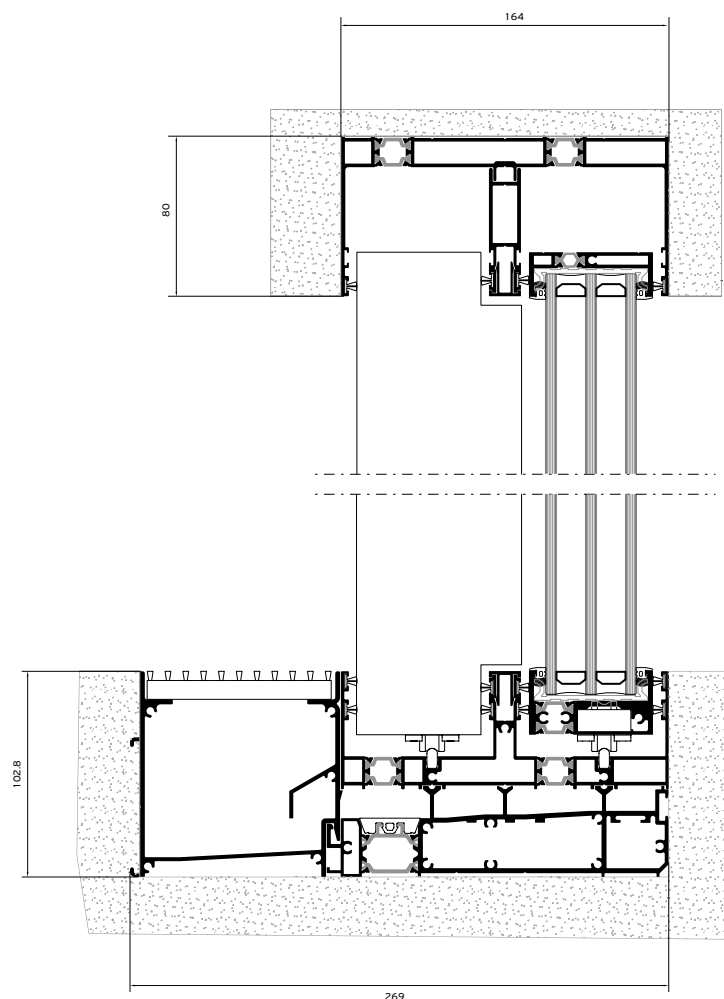

2 Sashes / 2 Track Low Threshold

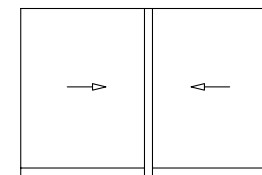

Even when the low threshold is selected for top-mounted installation, there is a special component for the concealed water drainage that offers high watertightness.

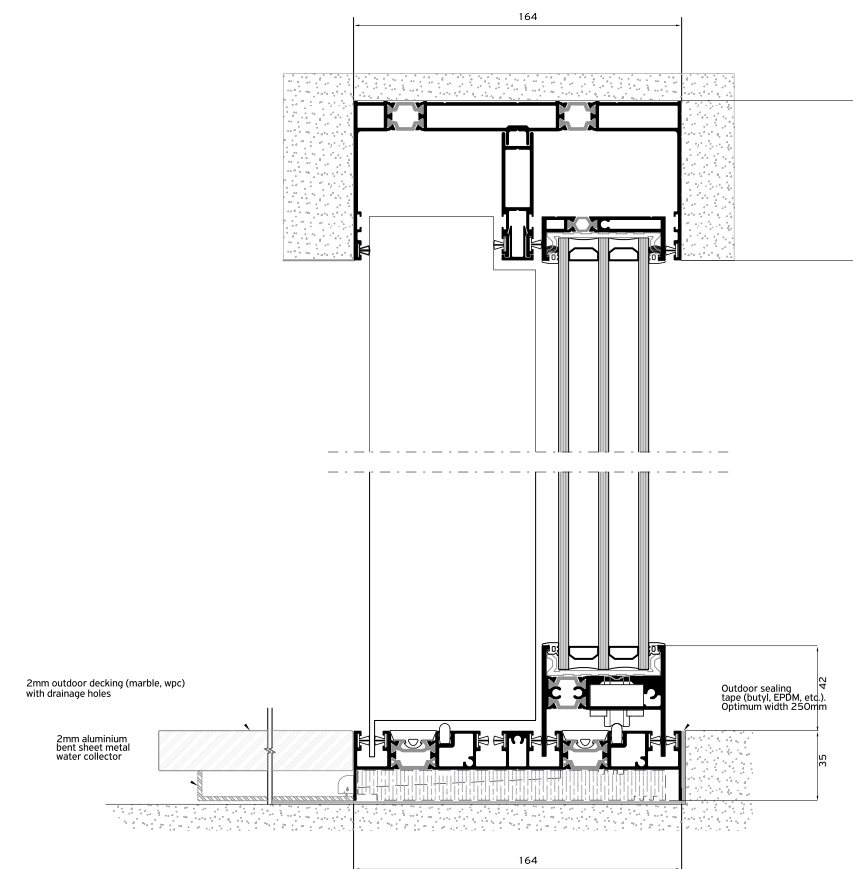

3 Sashes / 3 Track

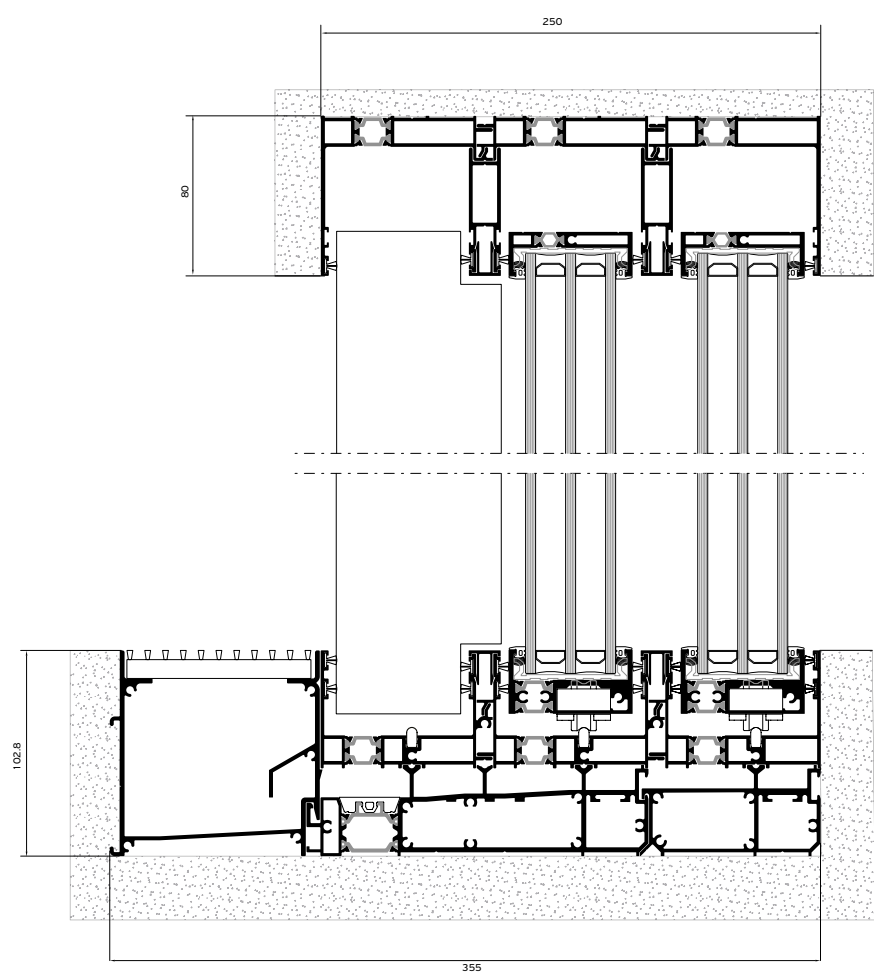
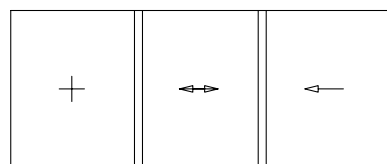

3 Sashes / 3 Track Low Threshold

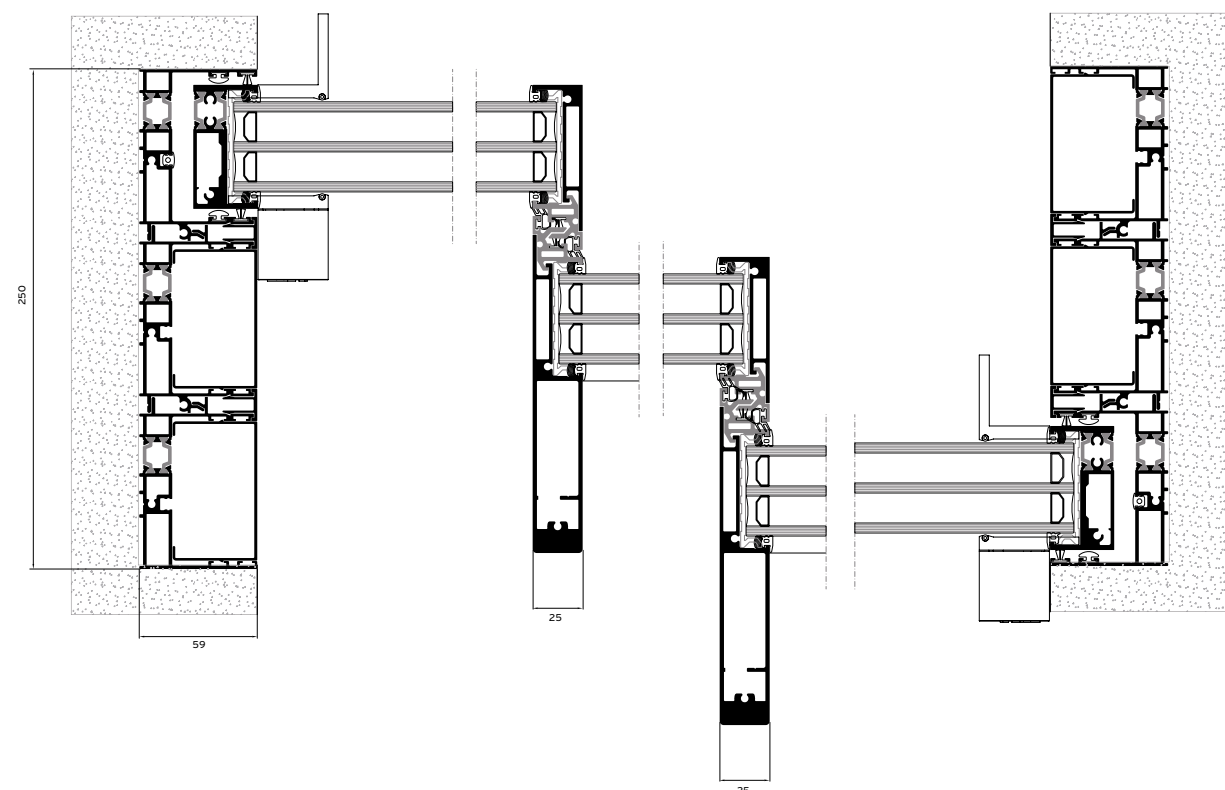
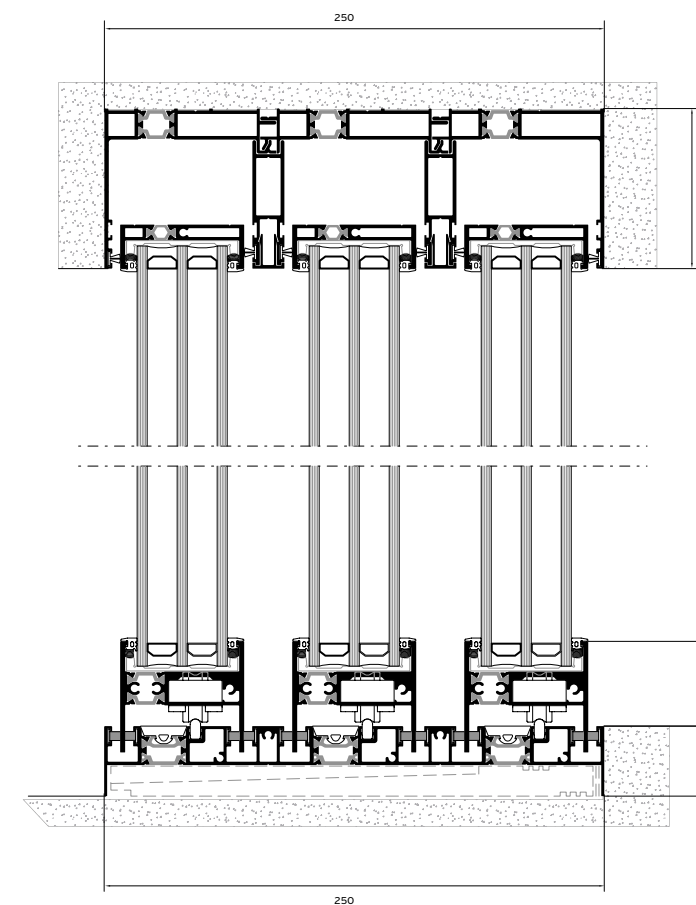
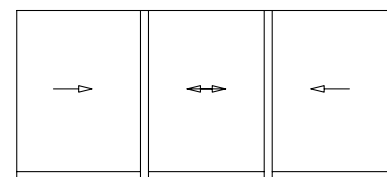

4 Sashes / 2 Track

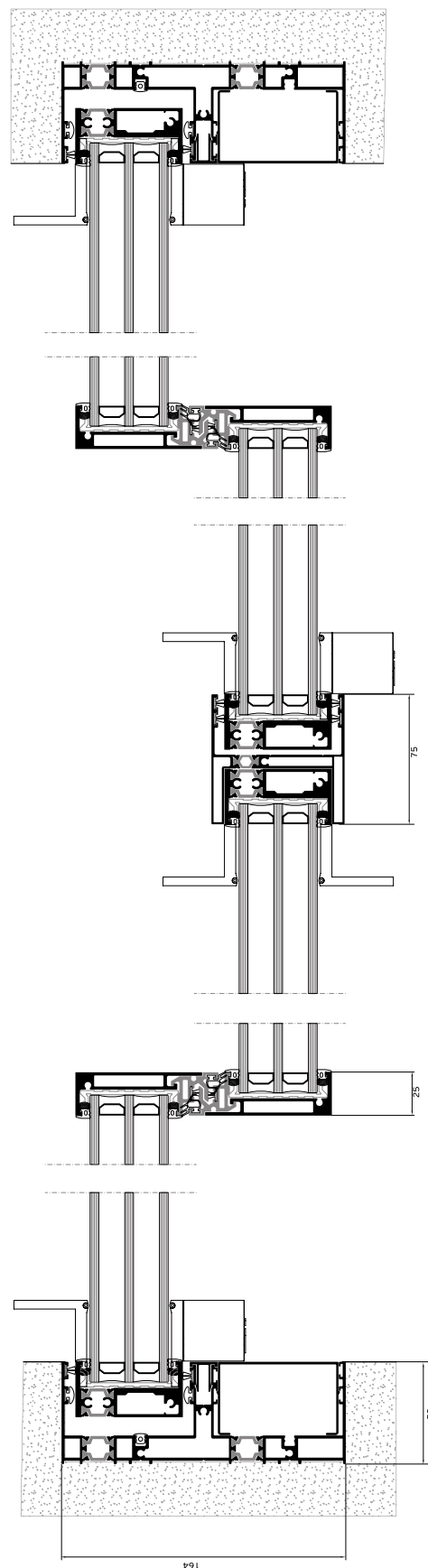
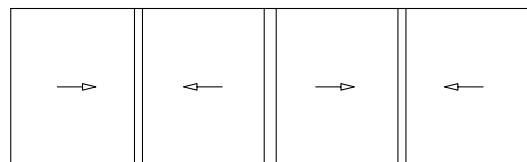

MULTI TRACK

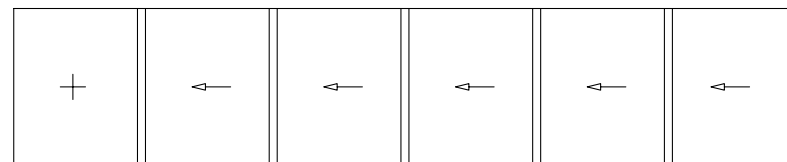

"No limits at the number of the horizontal sashes with the multi track typologies"

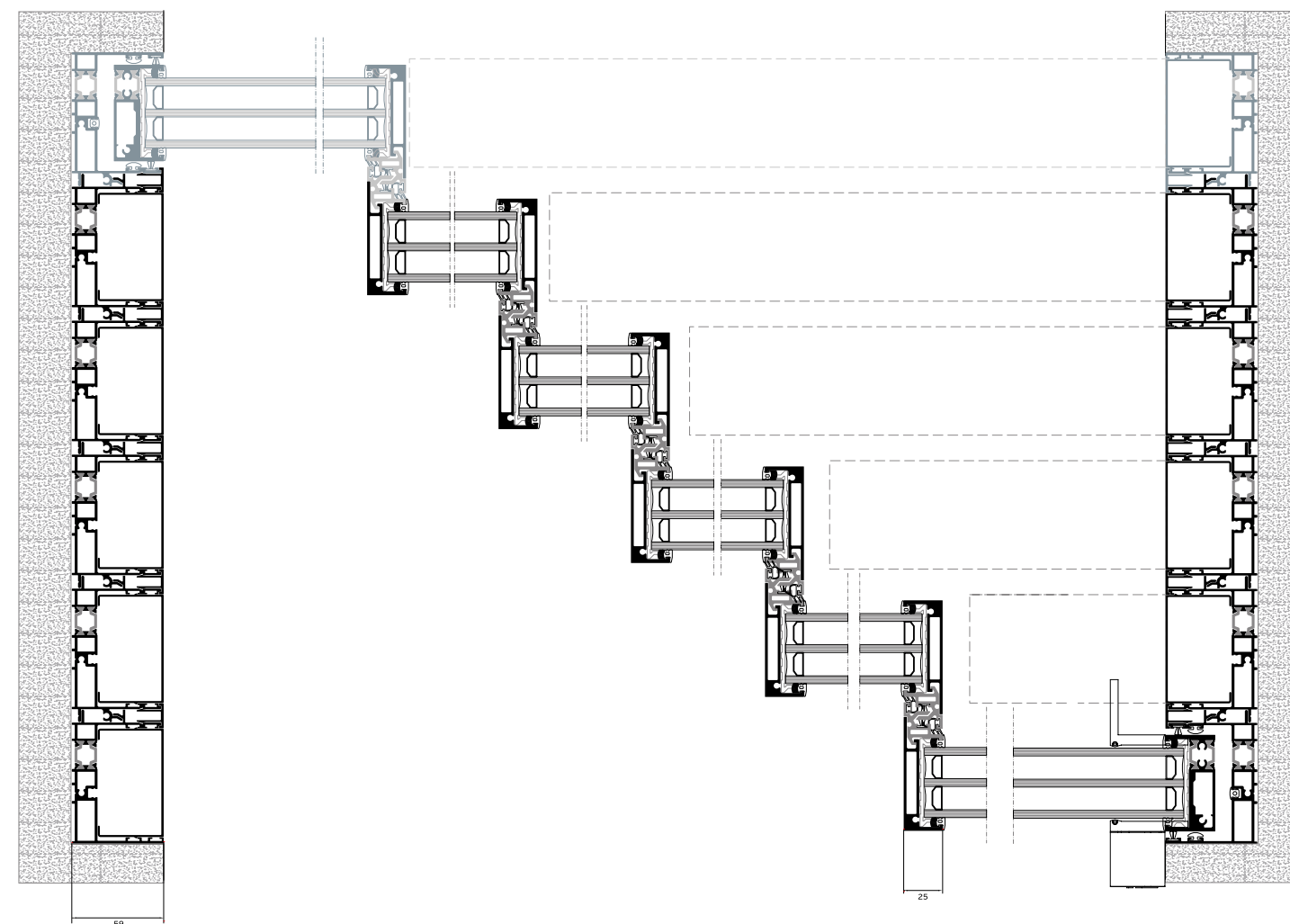

90°
Rotate the technical drawing
90° CLOCKWISE IN ORDER
TO READ IT PROPERLY

POCKET WINDOW 1 Sash / 1 Track

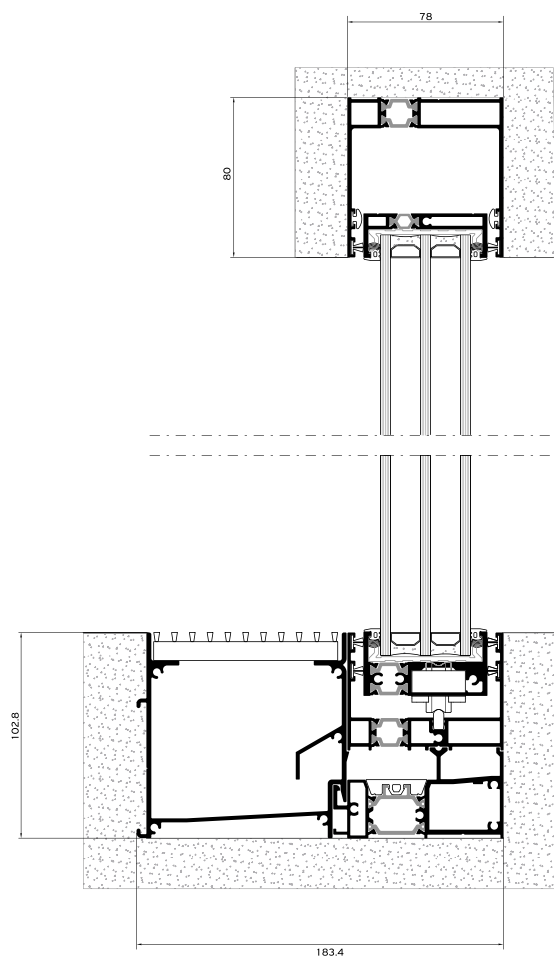
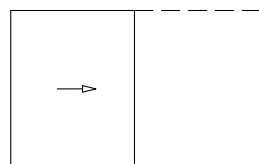

POCKET WINDOW 2 Sashes / 1 Track

2 Sashes / 1 Track

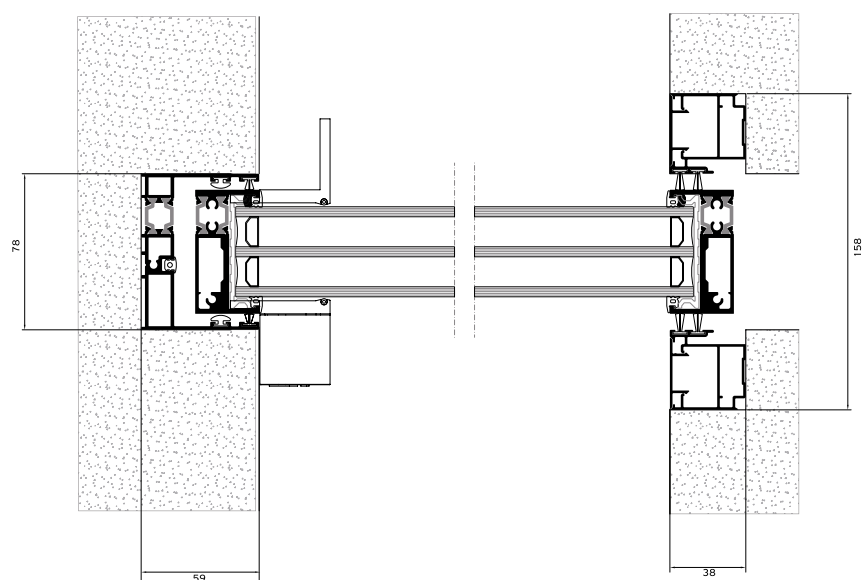
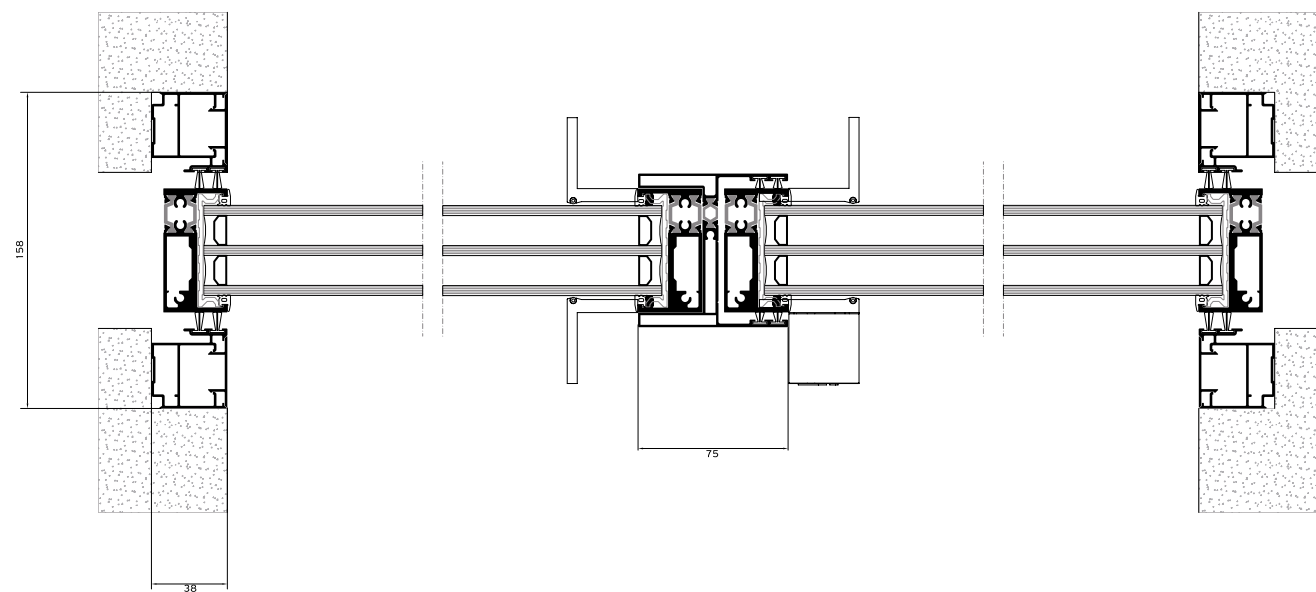
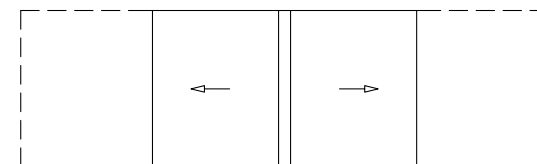

POCKET WINDOW Multi Track

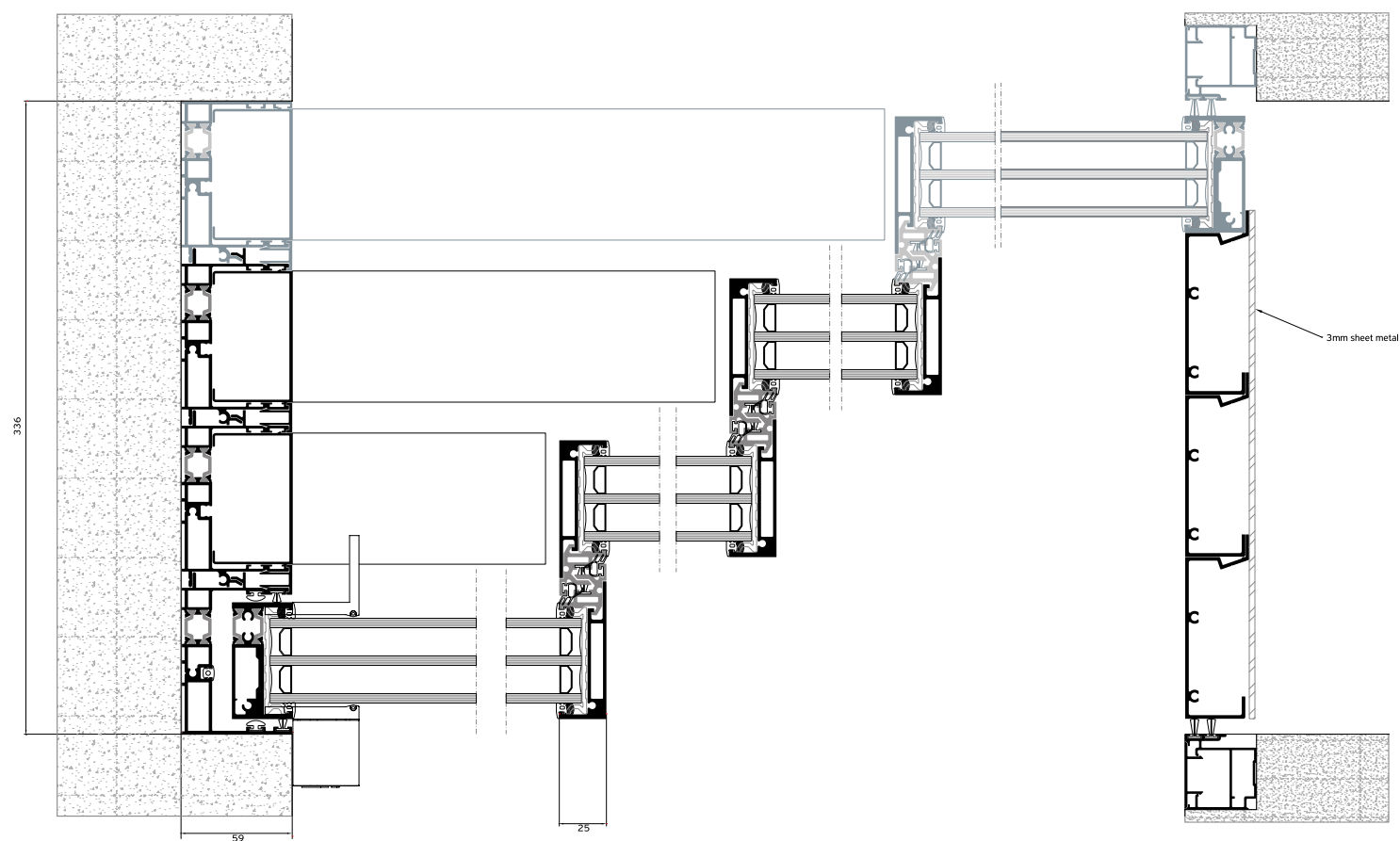
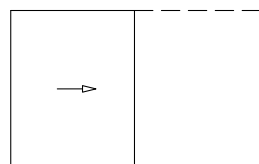

EXTERNAL CORNER

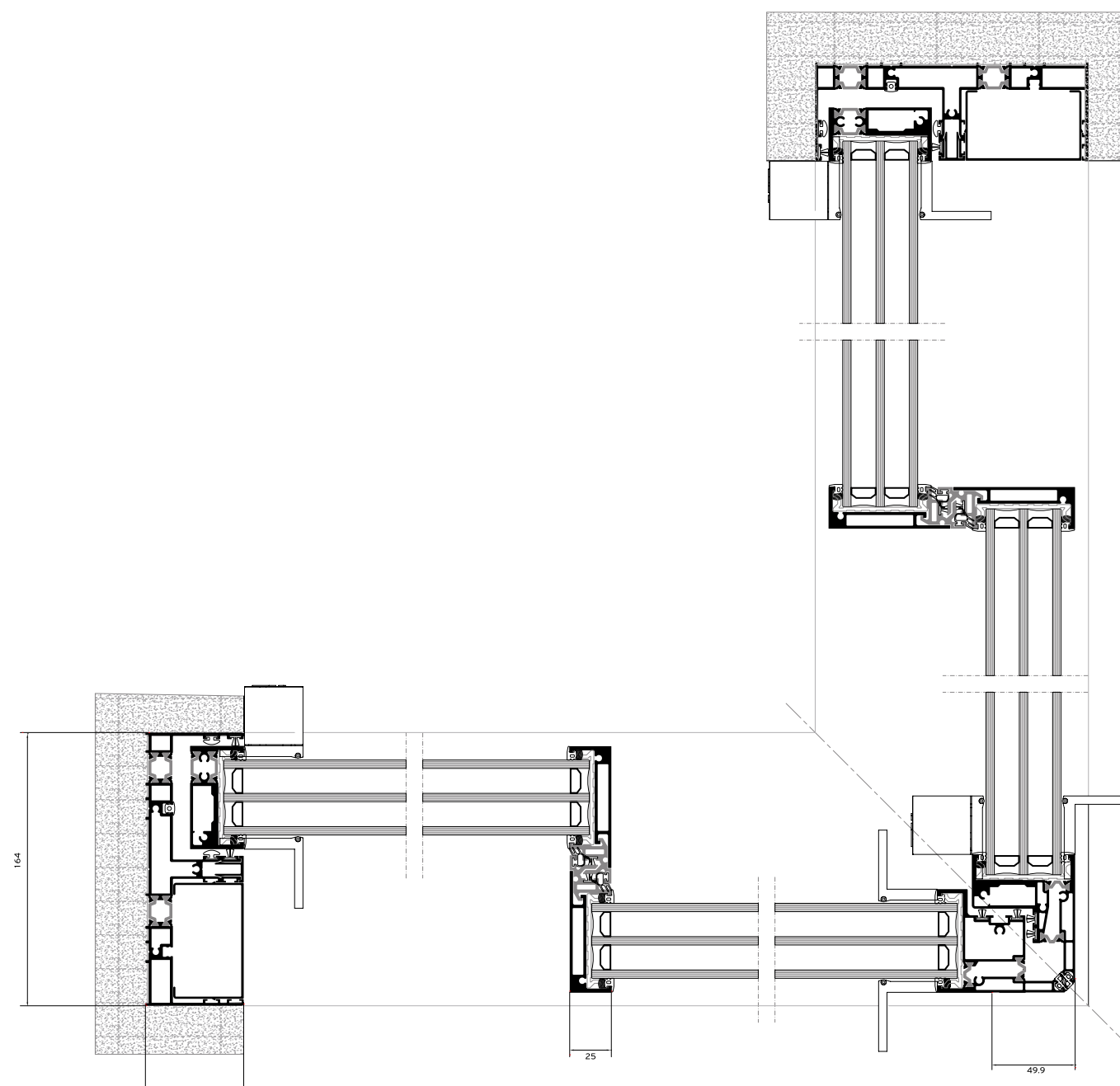
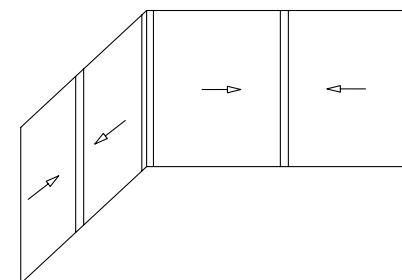

CORNER CONSTRUCTIONS WITHOUT USING INTERMEDIATE MULLIONS OFFER:

- MAXIMUM NATURAL LIGHT
- EASY OF ACCESS
- MINIMAL DESIGN
- HIGH FUNCTIONALITY

STIFFENERS

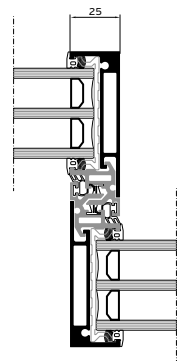

I=34,8 cm⁴

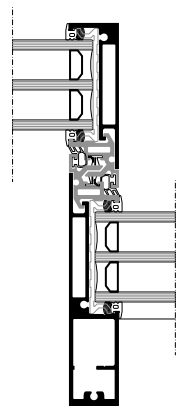

I=101,4 cm⁴

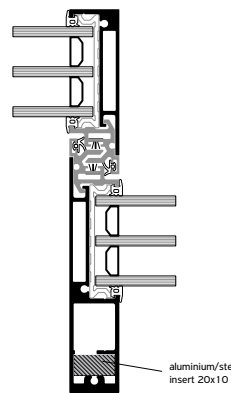

I=114,1 cm⁴

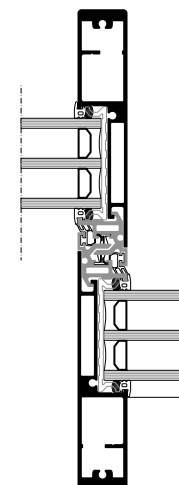

I=168 cm⁴

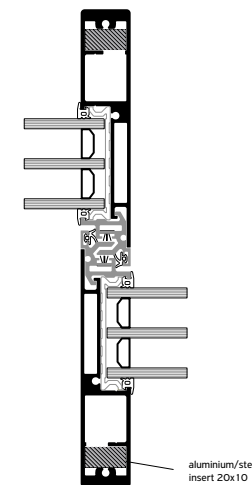

I=193,4 cm⁴

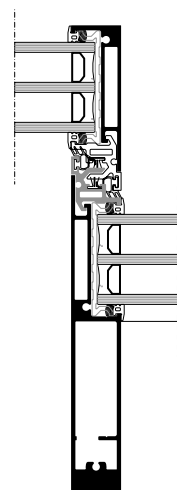

I=245,4 cm⁴

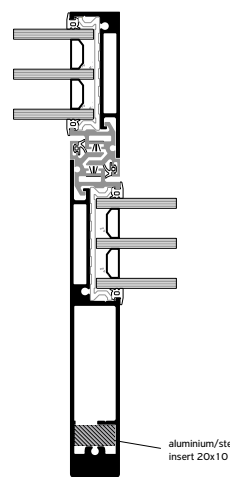

I=267,4 cm⁴

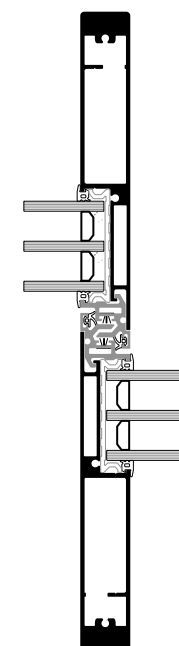

I=456 cm⁴

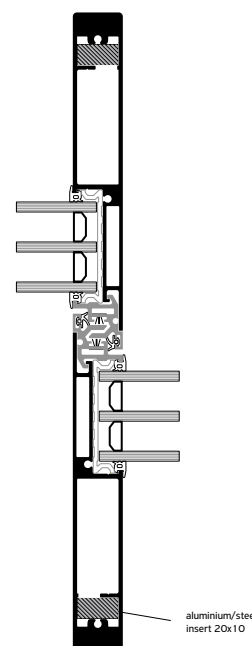

I=500 cm⁴

GLAZING TYPES

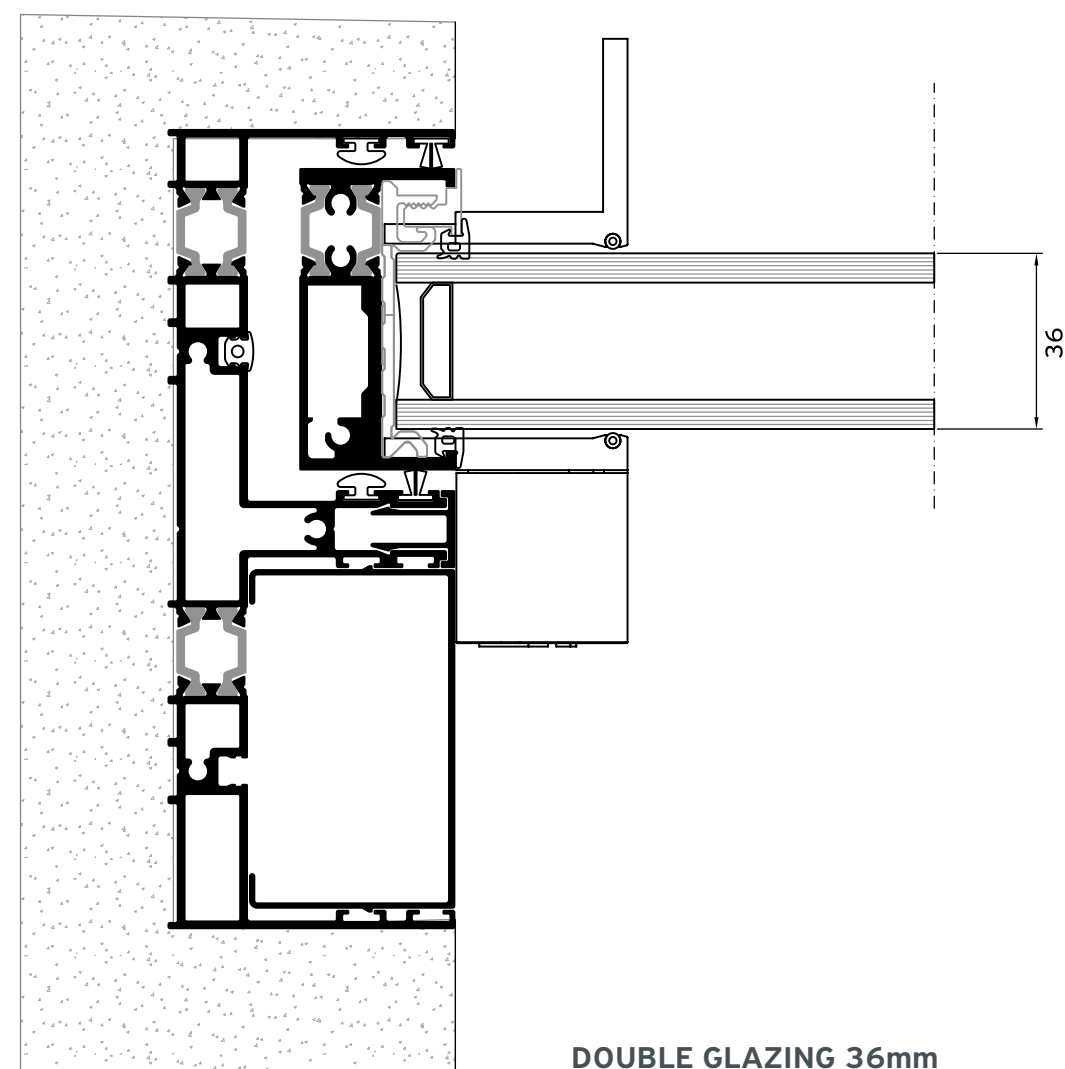
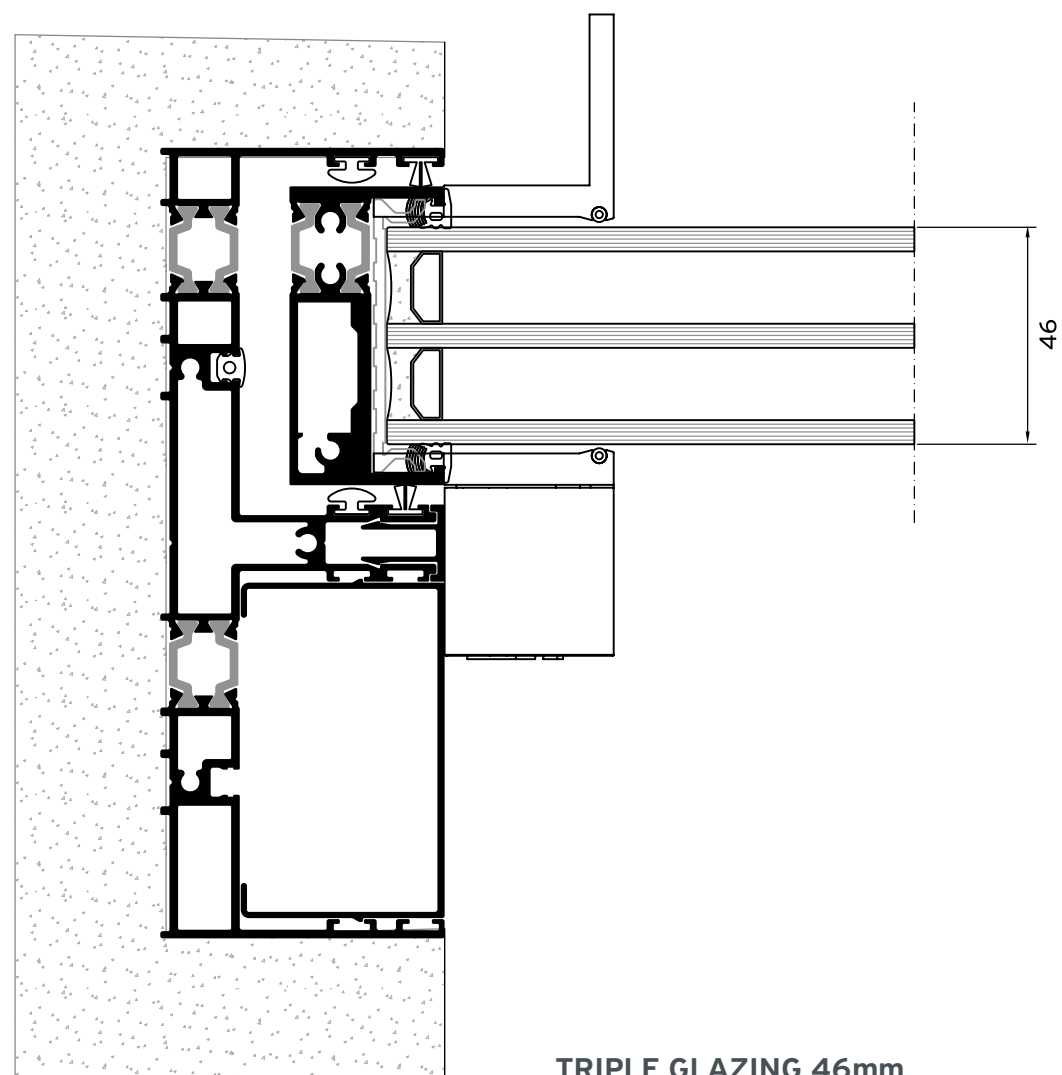

Alumil SUPREME
S650 eclipse

The innovative invisible track is totally integrated into the floor and covered with the floor finish offering a **flat surface** and creating continuity between the interior and the exterior environment.

THE ABSOLUT

MINIMAL DESIGN

DESIGNED TO MEET THE ARCHITECTURAL DEMANDS OF MINIMAL THERMALLY INSULATED SLIDING SYSTEMS WITH MINIMUM ALUMINUM SIGHT LINES.



- Invisible bottom frame totally flush to the floor
- Profiles totally concealed in-wall for maximum natural light
- Only 25 mm visible aluminium face width at the interlocking profile
- Concealed water drainage with high performance
- Stainless steel rollers easily replaced for maintenance
- New inox philosophy for flawless sash gliding & durability overtime

Alumil > SUPREME
S650 eclipse

TECHNICAL

CHARACTERISTICS



VISIBLE ALUMINIUM FACE WIDTH

CONCEALED PROFILES

FRAME HEIGHT

61 mm

FRAME WIDTH

180 mm

SASH HEIGHTS

22 / 45 mm

SASH WIDTH

62 mm

INTERLOCKING PROFILE WIDTH

25 mm

SASH WEIGHT

1000 Kg

GLAZING

36 / 46 mm

INSULATION

POLYAMIDES, PVC

2 Sashes / 2 Track

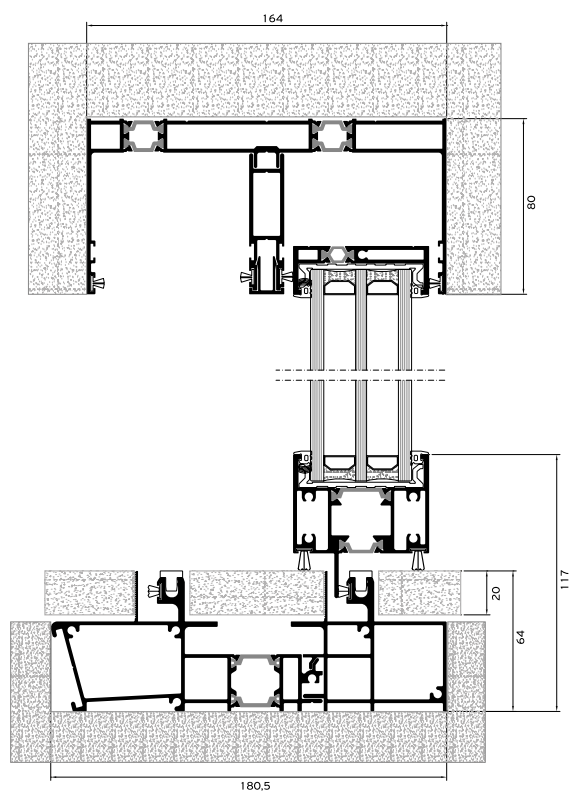
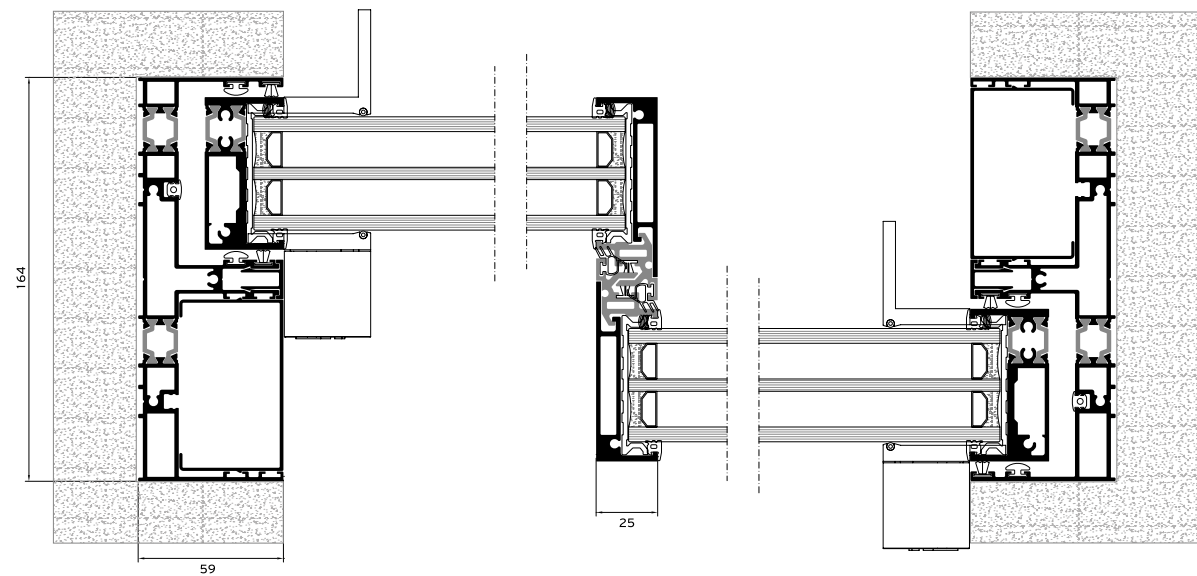
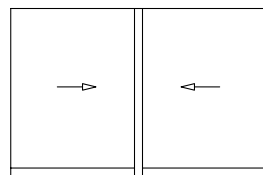

3 Sashes / 3 Track

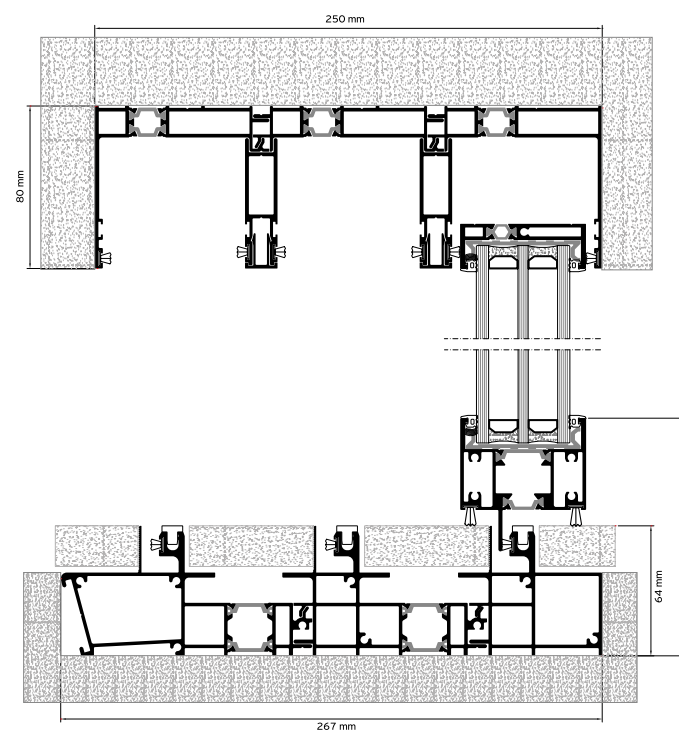
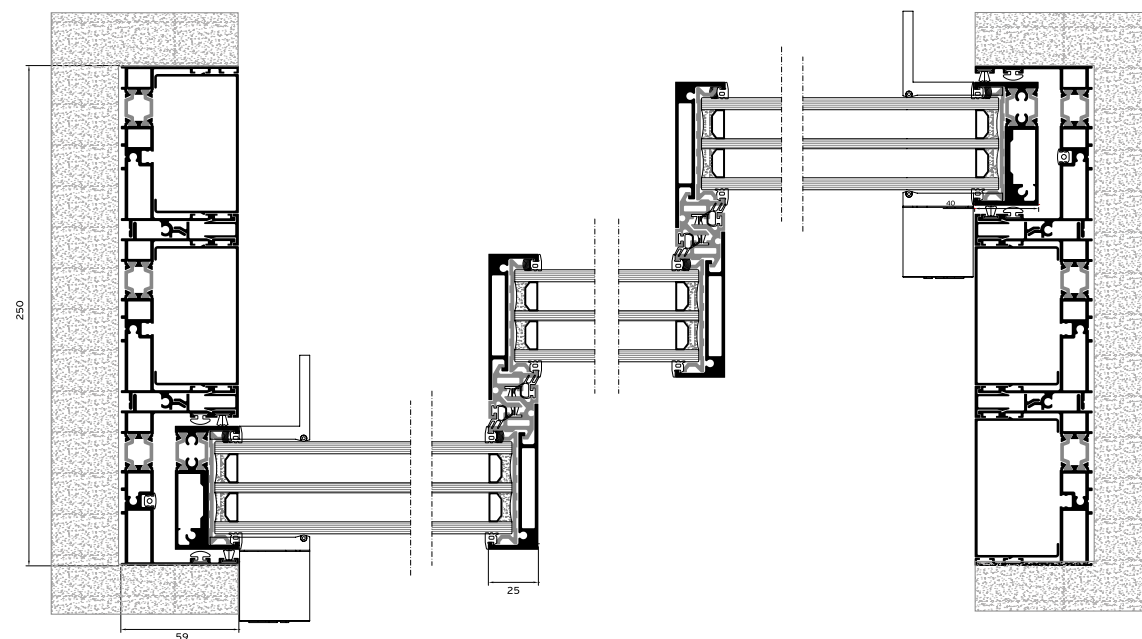
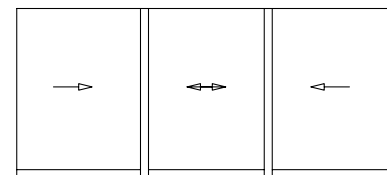

Alumil SUPREME

S650 e-MOTION

FUNCTIONALITY, CREDIBILITY

COMFORT

AUTOMATED VERSION

The supreme S650 e-Motion is the automated version of the supreme S650 PHOS series.

The elegant design and the electrical automation offering maximum ease of use, make it the perfect solution for projects that require impressive wide spans with uninterrupted view, as well as perfect comfort.

- All the aluminum profiles are totally concealed in-wall so as to maximize natural lighting
- Remote controlled electric motion for ease of use
- Maximum safety through a central control system (motion sensors, electromagnetic locking and fire detection), which is compatible with smart house applications

- Narrow interlocking profile with only 25mm visible aluminum face width
- Can be operated in case of blackout thanks to the integrated rechargeable battery
- Manual operation possible in case of emergency
- Extra concealed profiles available for water drainage



Alumil SUPREME
S650 e-MOTION

TECHNICAL

CHARACTERISTICS

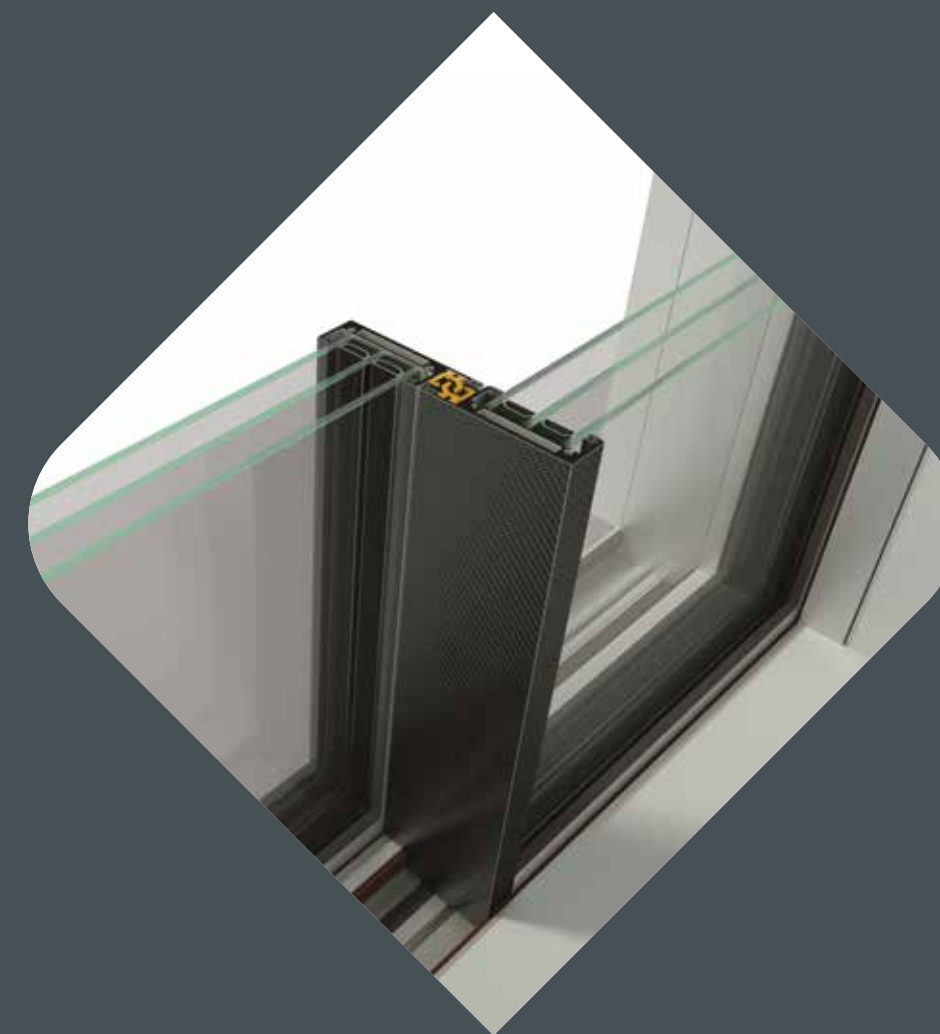

VISIBLE ALUMINIUM FACE WIDTH

CONCEALED PROFILES

FRAME HEIGHT

45 mm

FRAME WIDTH

174 mm

SASH HEIGHTS

25 / 32 mm

SASH WIDTH

67,4 mm

INTERLOCKING PROFILE WIDTH

25 mm

SASH WEIGHT

1000 Kg

GLAZING

36 / 46 mm

INSULATION

POLYAMIDES, PVC

2 Sashes / 2 Track

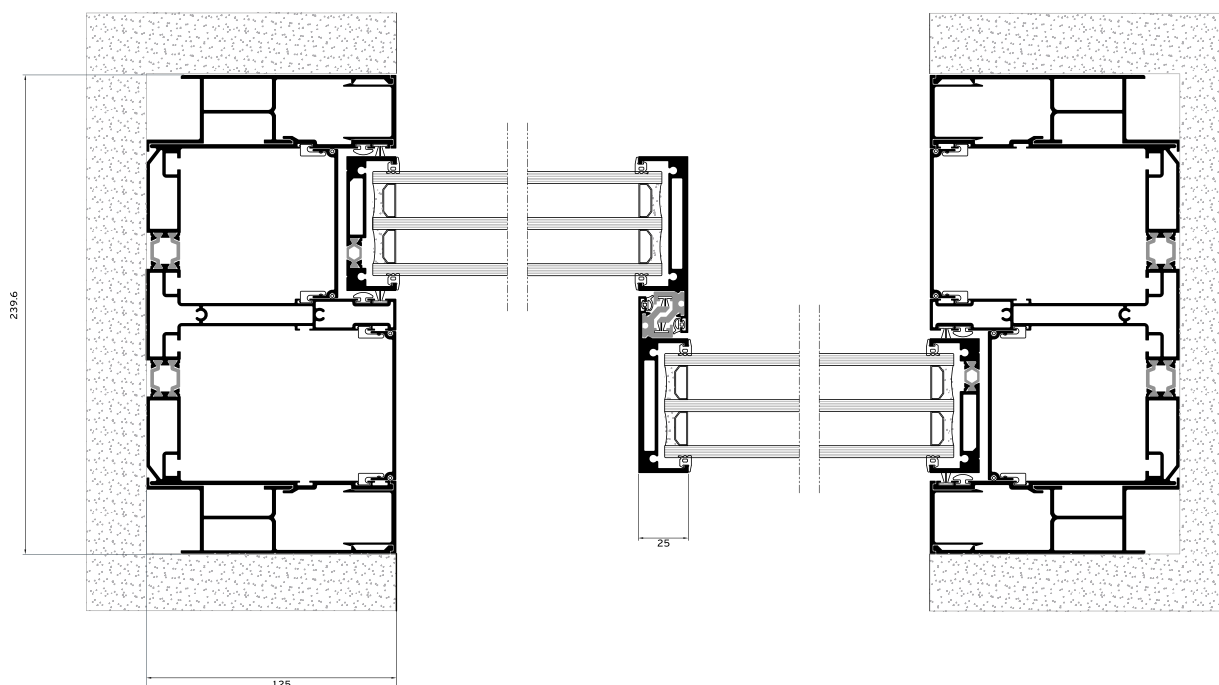
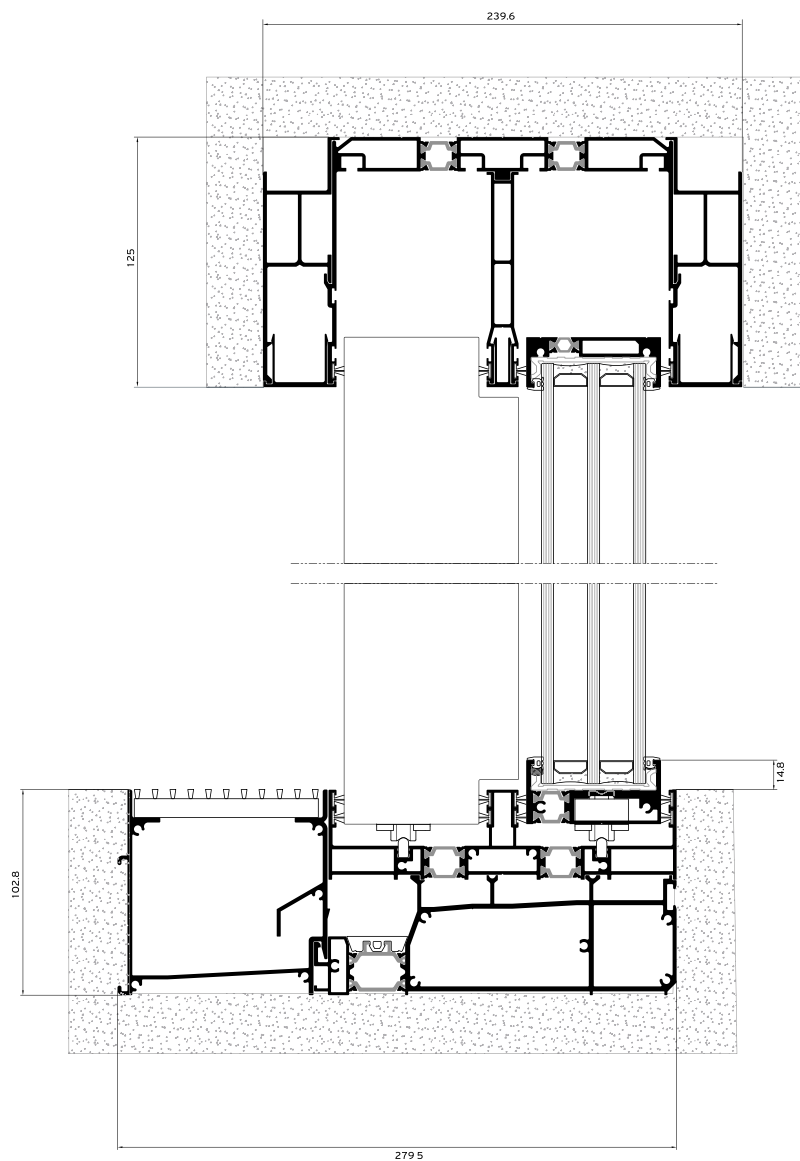
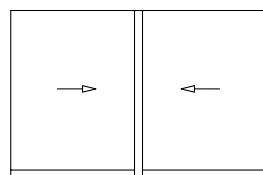

ALTERNATIVE

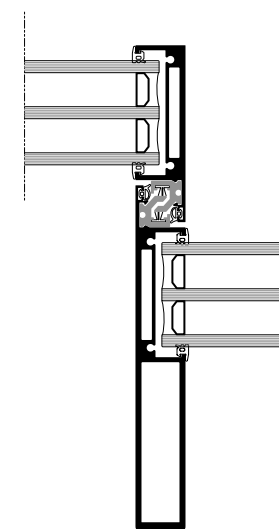

4 Sashes / 2 Track



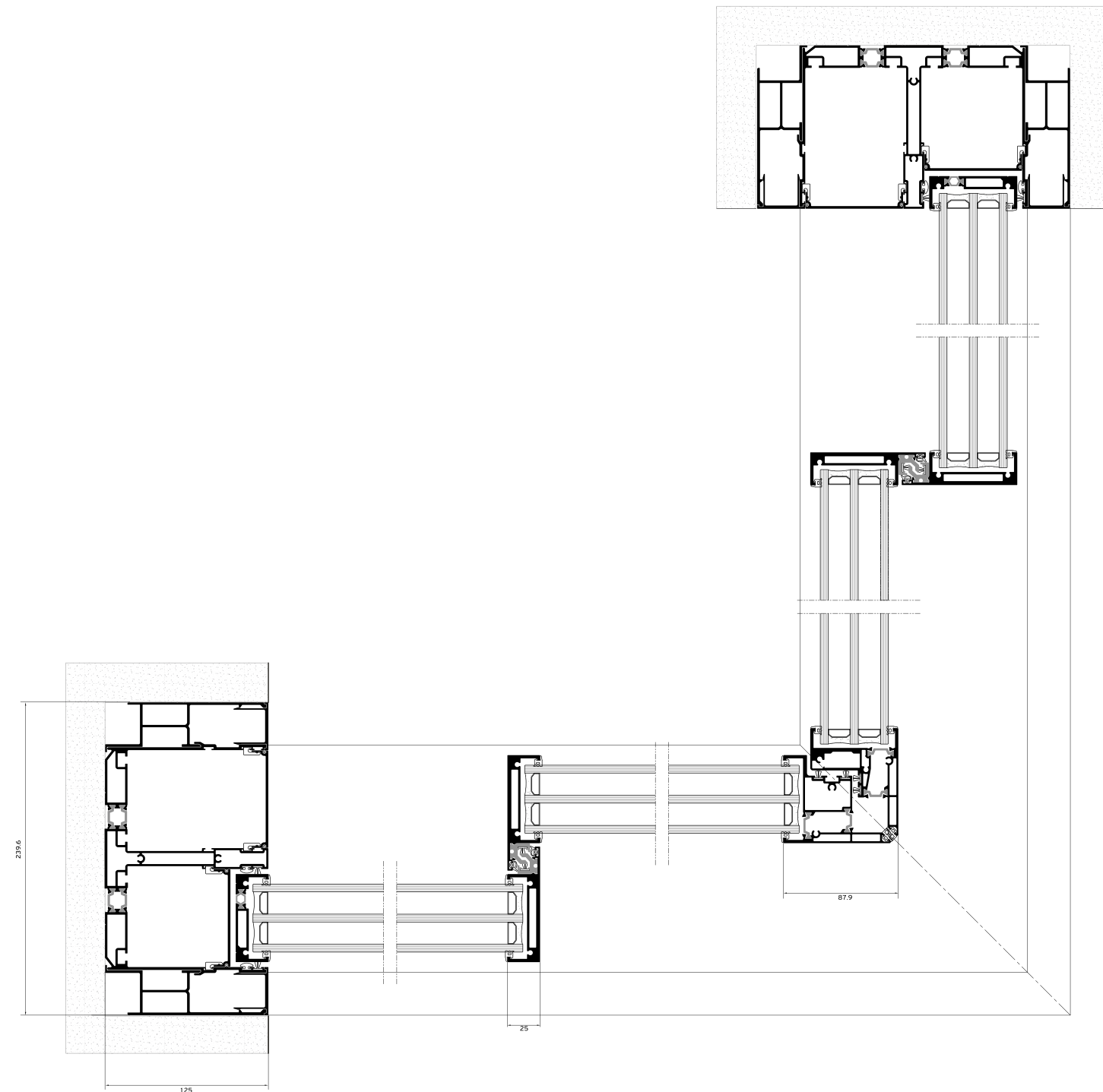
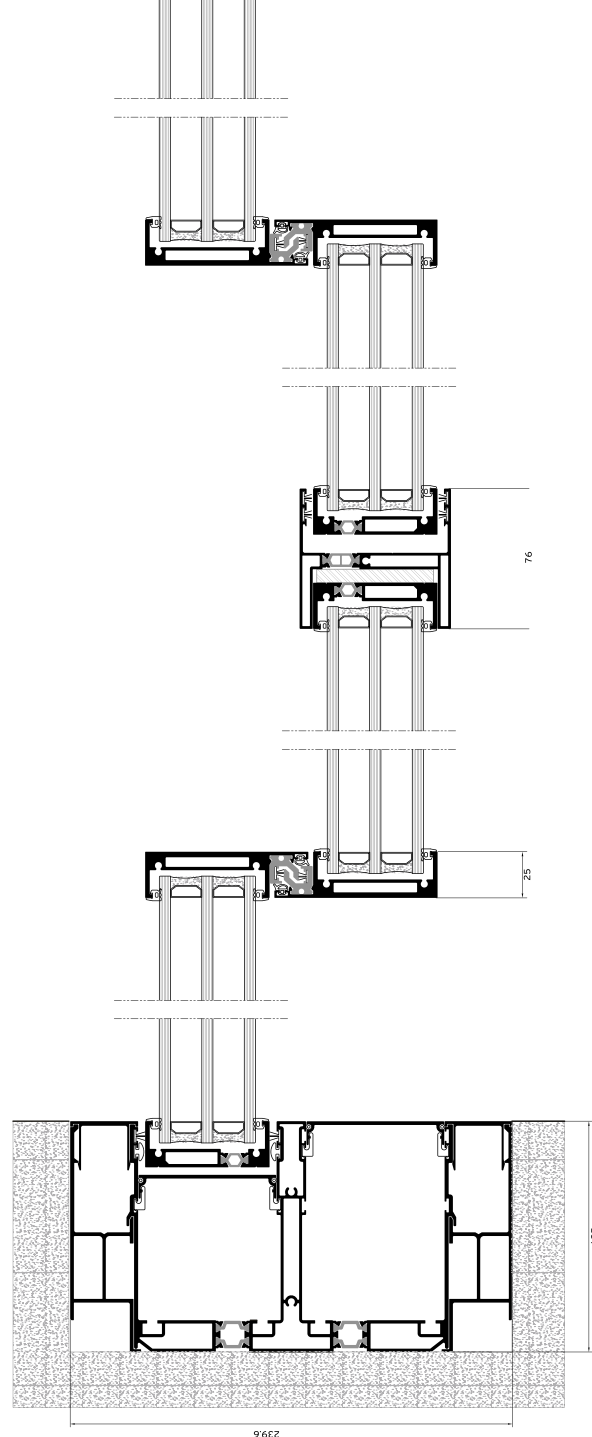
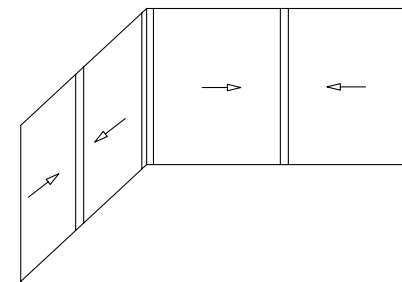
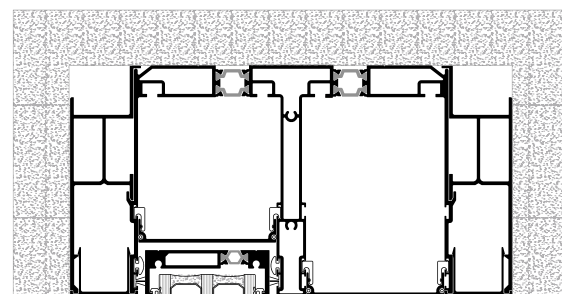
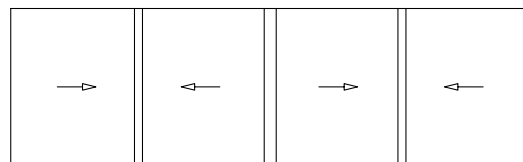









EXTERNAL CORNER

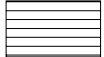

90°
Rotate the technical drawing
90° CLOCKWISE IN ORDER
TO READ IT PROPERLY

Installation

Alumil SUPREME
S650 PHOS

-  PRECOMPRESSED MULTI-FUNCTION SEALING TAPE
-  BACKER ROD
-  HYBRID SEALANT OR NEUTRAL SILICONE
-  STYRODUR HIGH DENSITY BOARD
-  TILES
-  MARBLE
-  POLYURETHANE FOAM
-  POLYSTYRENE
-  WALL CONSTRUCTION
-  WALL FINISH
-  REINFORCED CONCRETE
-  AIR WATER VAPOR BARRIER TAPE

SIDE SECTION

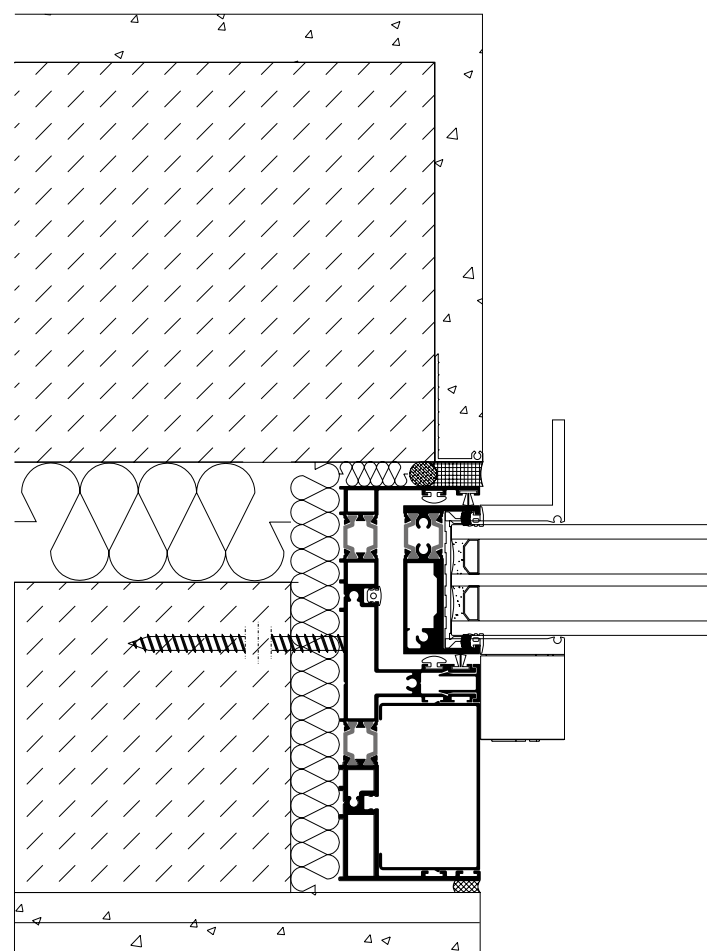

Alumil SUPREME
S650 PHOS

TOP SECTION

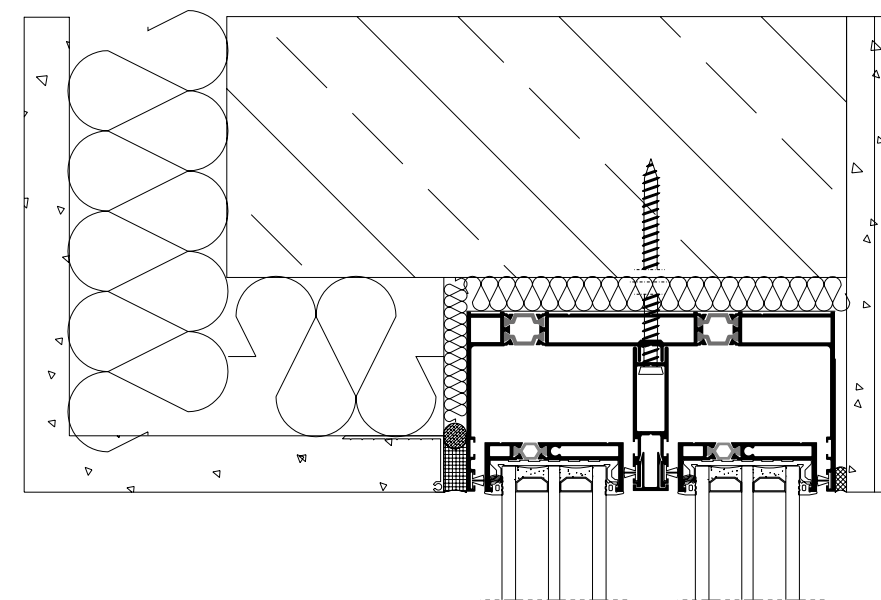

Installation

Alumil > SUPREME
S650 PHOS

BOTTOM SECTION WITH GUTTER

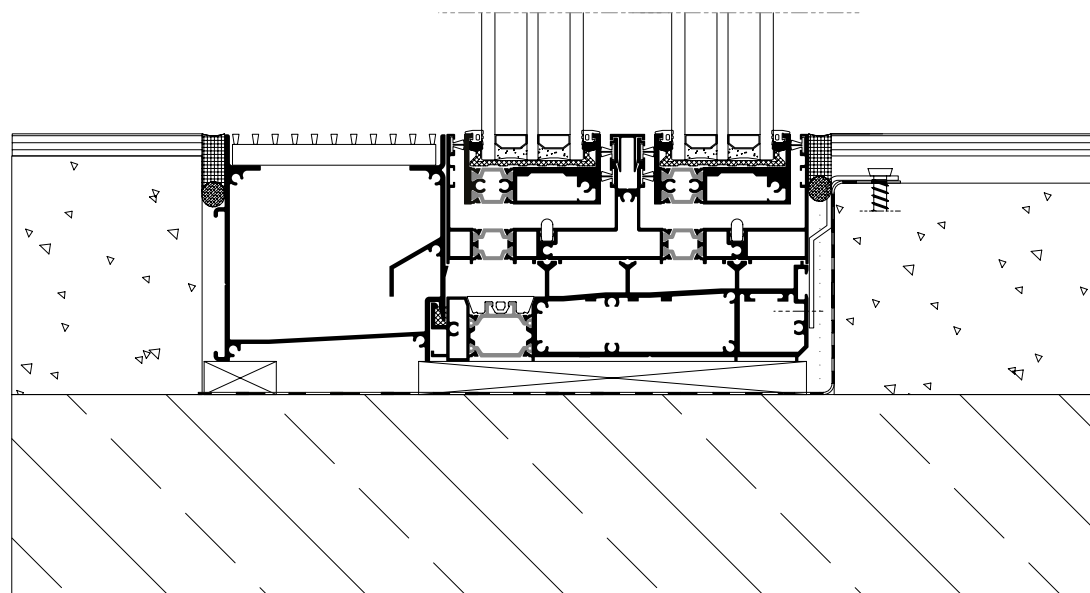

Alumil > SUPREME
S650 eclipse

BOTTOM SECTION ECLIPSE

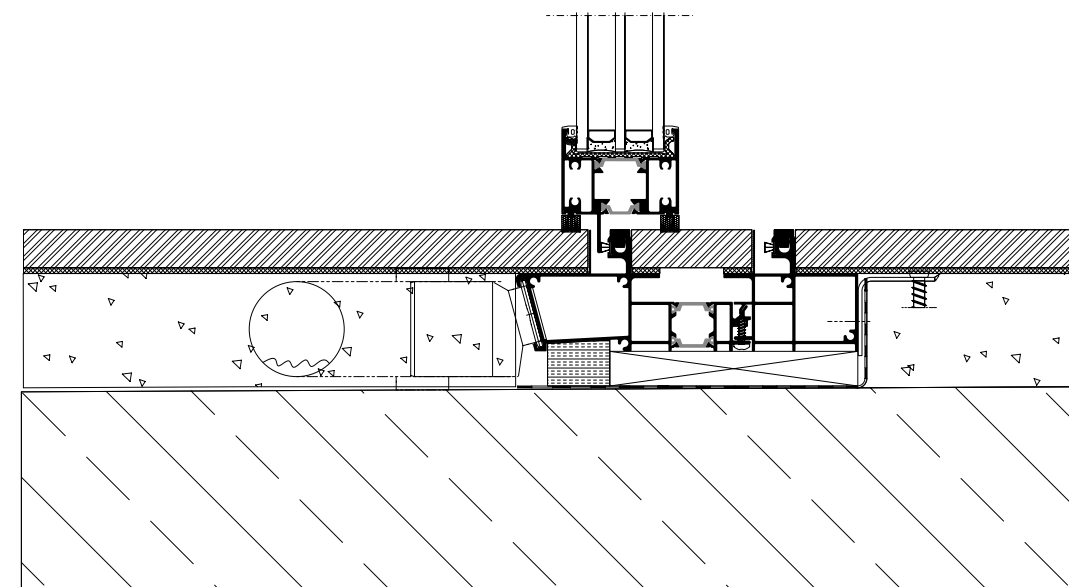

Installation

Alumil > SUPREME
S650 PHOS

BOTTOM SECTION WITH LOW TRACK A

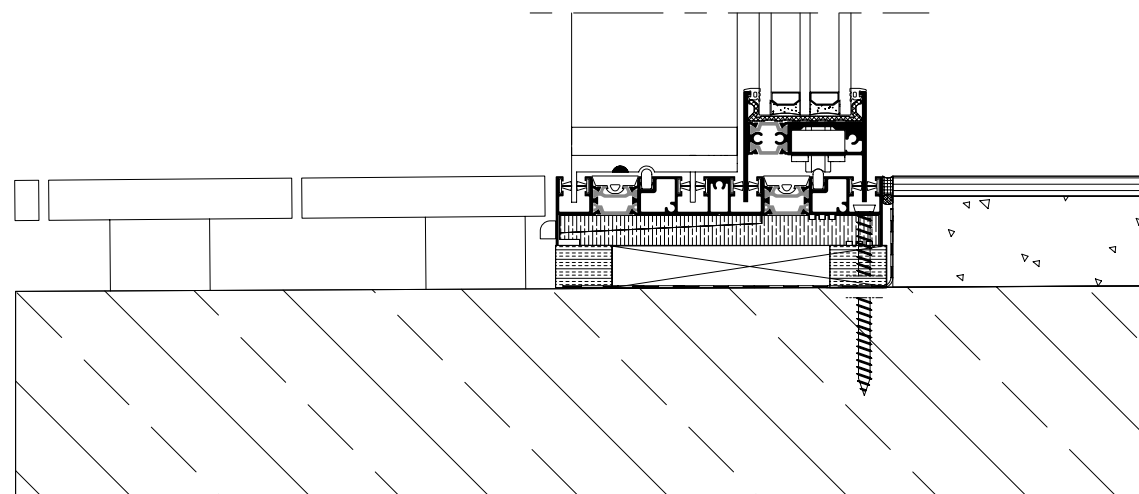

BOTTOM SECTION WITH LOW TRACK C

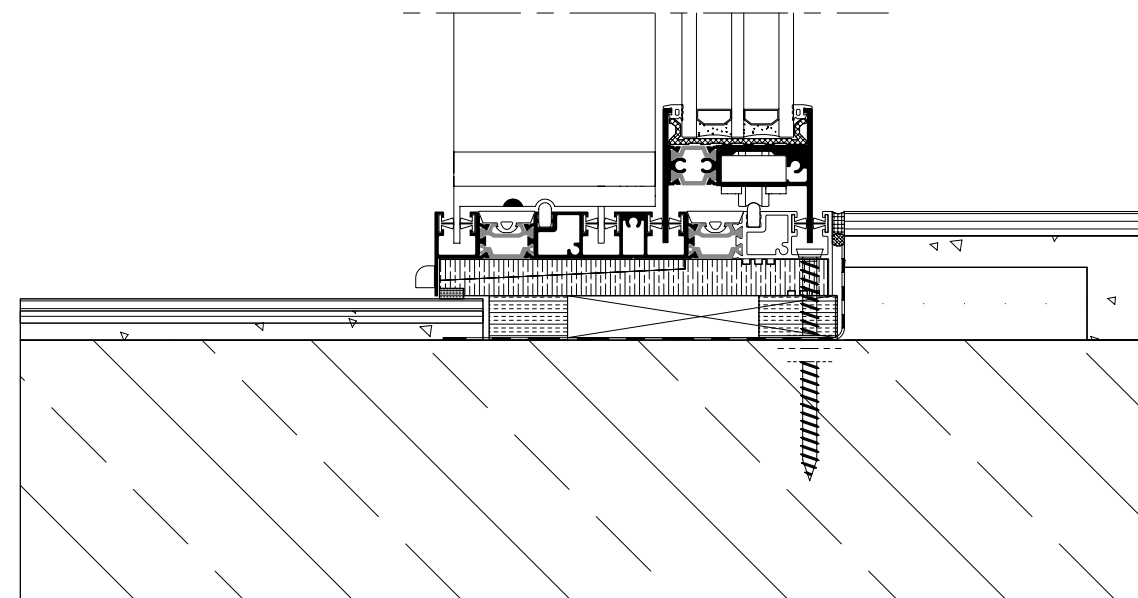

BOTTOM SECTION WITH LOW TRACK B

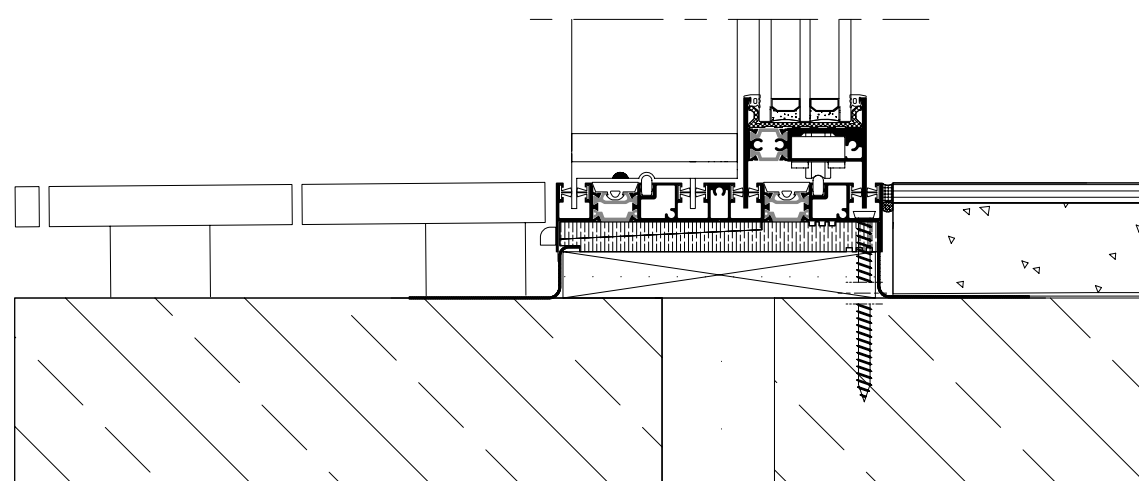

BOTTOM SECTION WITH LOW TRACK D

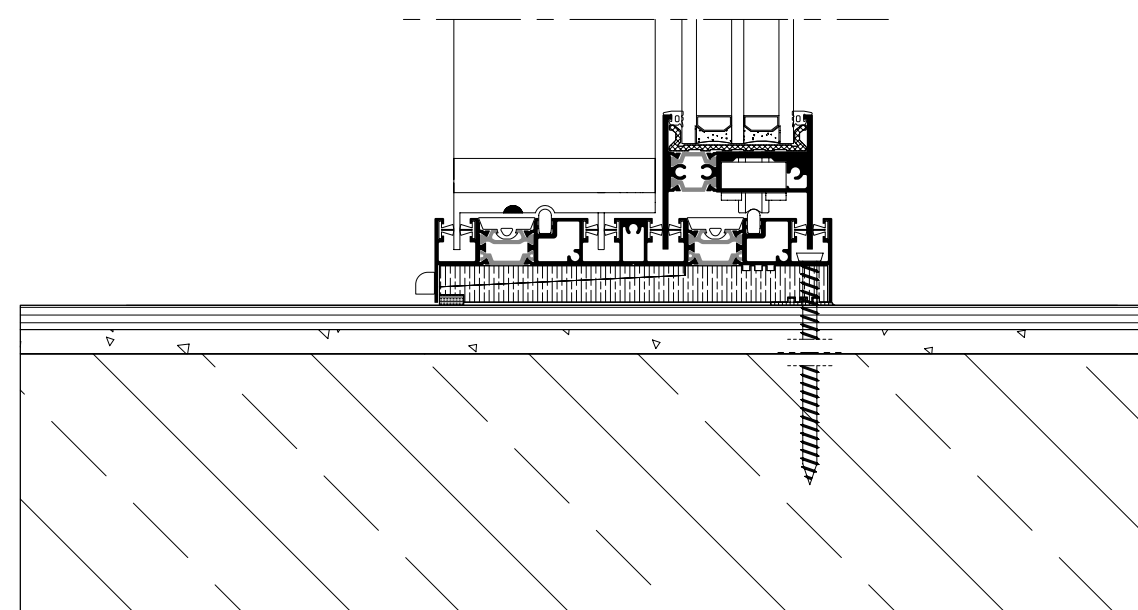

Applications

Alumil SUPREME S650 PHOS

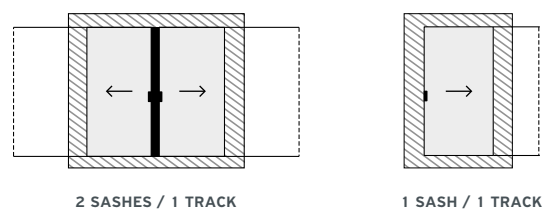
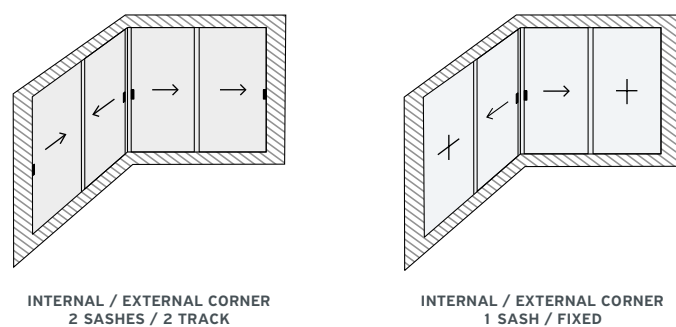
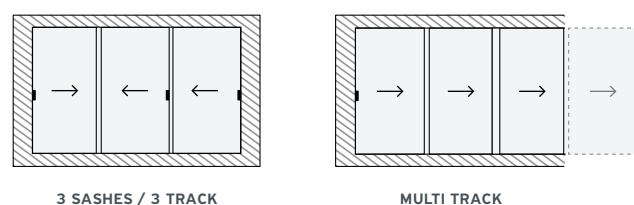
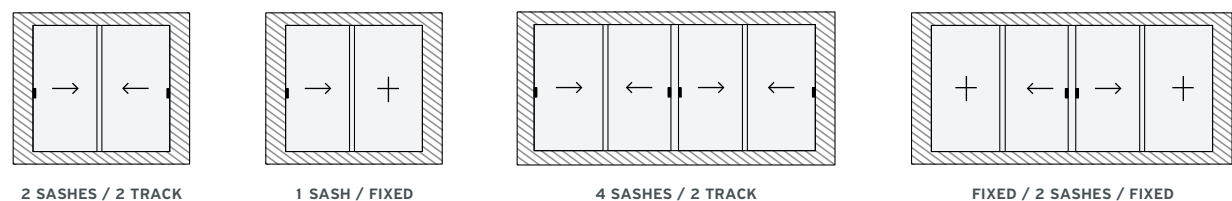

Alumil SUPREME S650 eclipse

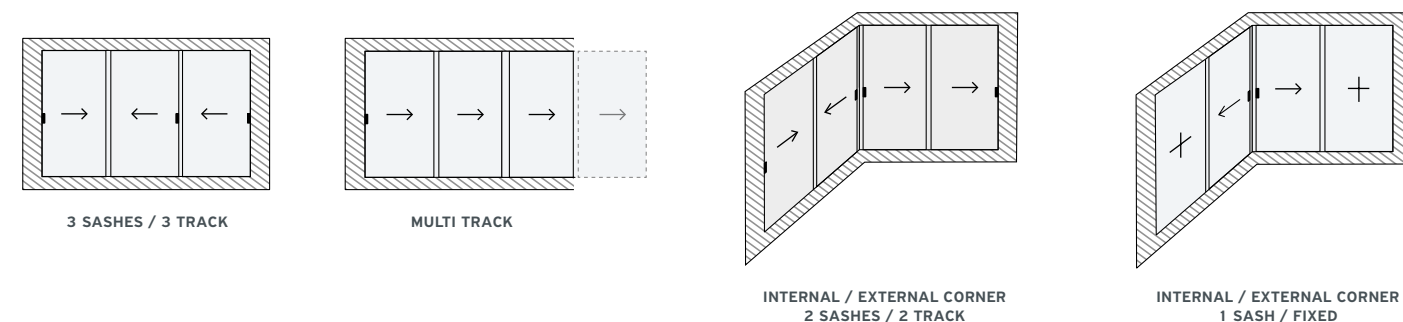
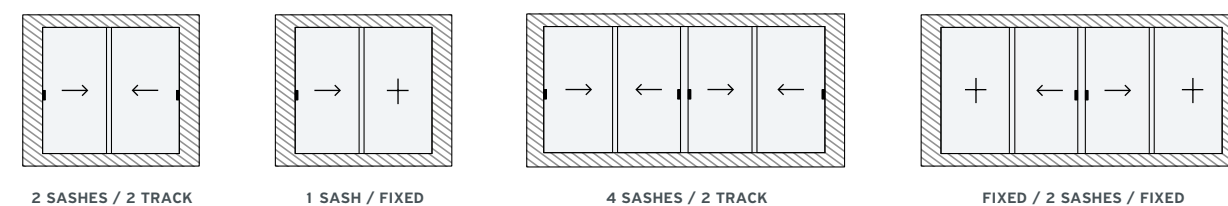

Alumil SUPREME S650 e-MOTION

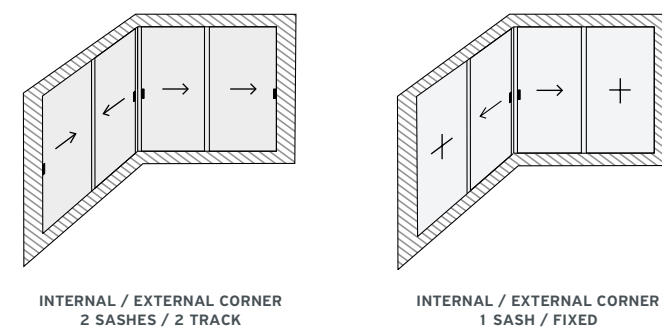
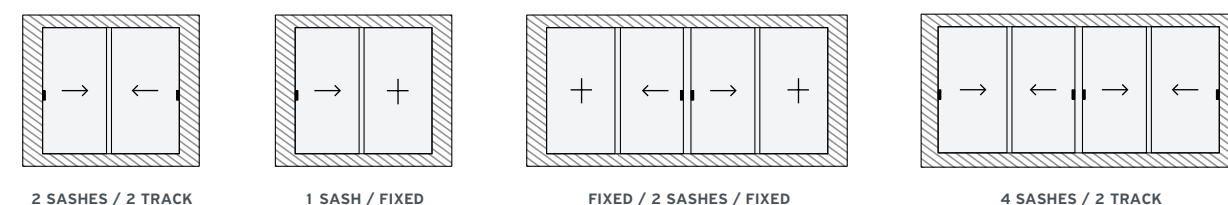







TABLE OF PERFORMANCE

SUPREME S650 PHOS

CERTIFICATION

CLASSIFICATION





 WATER TIGHTNESS EN 12208	1A (0 Pa)	2A (50 Pa)	3A (100 Pa)	4A (150 Pa)	5A (200 Pa)	6A (250 Pa)	7A (300 Pa)	8A (450 Pa)	9A (600 Pa)
 AIR PERMEABILITY EN 12207		1 (150 Pa)		2 (300 Pa)		3 (600 Pa)			4 (600 Pa)
 WIND RESISTANCE MAX TEST PRESSURE EN 12210	1 (400 Pa)		2 (800 Pa)		3 (1200 Pa)		4 (1600 Pa)		5 (2000 Pa)
 WIND LOAD RESISTANCE TO FRONTAL DEFLECTION EN 12210	A (≤ 1/150)				B (≤ 1/200)				C (≤ 1/300)
 SOUND REDUCTION EN14351	41 dB								
 BURGLAR RESISTANCE EN 1627 - 1630	RC 1				RC 2				RC 3

Alumil has also certified the systems SUPREME S650 according to AAMA & AS standards which are available upon request.

SUPREME S650 eclipse

CERTIFICATION





CLASSIFICATION

 WATER TIGHTNESS EN 1208	1A (0 Pa)	2A (50 Pa)	3A (100 Pa)	4A (150 Pa)	5A (200 Pa)	6A (250 Pa)	7A (300 Pa)	8A (450 Pa)	9A (600 Pa)
 AIR PERMEABILITY EN 12207		1 (150 Pa)		2 (300 Pa)		3 (600 Pa)			4 (600 Pa)
 WIND LOAD RESISTANCE MAX. TEST PRESSURE EN 12210	1 (400 Pa)		2 (800 Pa)		3 (1200 Pa)		4 (1600 Pa)		5 (2000 Pa)
 WIND LOAD RESISTANCE TO FRONTAL DEFLECTION EN 12210	A (≤ 1/150)				B (≤ 1/200)				C (≤ 1/300)
 SOUND REDUCTION EN14351	46dB								

SUPREME S650 e-MOTION

CERTIFICATION

CLASSIFICATION

 WATER TIGHTNESS EN 12208	1A (0 Pa)	2A (50 Pa)	3A (100 Pa)	4A (150 Pa)	5A (200 Pa)	6A (250 Pa)	7A (300 Pa)	8A (450 Pa)	9A (600 Pa)	E 1050 (1050 Pa)
 AIR PERMEABILITY EN 12207		1 (150 Pa)		2 (300 Pa)			3 (600 Pa)			4 (600 Pa)
 WIND RESISTANCE MAX TEST PRESSURE EN 12210	1 (400 Pa)		2 (800 Pa)		3 (1200 Pa)		4 (1600 Pa)		5 (2000 Pa)	
 WIND LOAD RESISTANCE TO FRONTAL DEFLECTION EN 12210		A (≤ 1/150)				B (≤ 1/200)				C (≤ 1/300)
 BURGLAR RESISTANCE EN 1627 - 1630		RC 1				RC 2			RC 3	

THERMAL

	DIMENSIONS IN MM (w x h)	U _w in W/m ² K (U _g = 0,6)	U _w in W/m ² K (U _g = 0,8)	U _w in W/m ² K (U _g = 1,1)
2 SASHES / 2 TRACK	2600 x 2400	1,14	1,32	1,59
2 SASHES / 2 TRACK LOW THRESHOLD	2600 x 2400	1,15	1,32	1,59
4 SASHES / 2 TRACK	5200 x 2400	1,12	1,30	1,57

Thermal performance for non-installed frames certified according to EN ISO 10077-2

REFERENCE PROJECTS

- 1. PRIVATE RESIDENCE / KOS, GREECE
- 2. PRIVATE RESIDENCE / THESSALONIKI, GREECE
- 3. PRIVATE RESIDENCE / ATHENS, GREECE
- 4. SKA VILLA LAGOS / NIGERIA, AFRICA
- 5. PRIVATE RESIDENCE / AEGINA, GREECE
- 6. MAYIA EXCLUSIVE RESORT & SPA / RHODES, GREECE



1

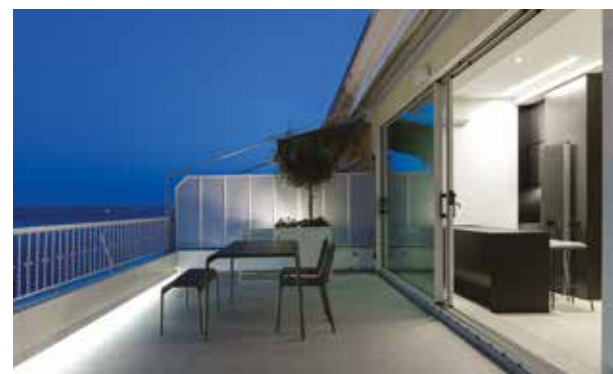

2



4



3



5



6

REFERENCE PROJECTS

- 7. EL HOUSE / CYPRUS
- 8. H 34 / VOULA, ATHENS
- 9. ALKYONIDES VILLAS / ZANTE, GREECE

- 10. THE LAP POOL HOUSE / TINOS, GREECE
- 11. HAESLEY CONDOMINIUM / SOUTH KOREA
- 12. ARISTOTELOUS RESIDENCE / THESSALONIKI, GREECE



7



10



11



8



9



12

www.alumil.com

**ALUMIL
HEAD OFFICES
& SHOWROOM - THESSALONIKI**

Gogousi 8, Efkarpia
Thessaloniki - GR 56429
TEL.: +30 2313011000
FAX.: +30 231692473
E-MAIL.: info@alumil.com

**ALUMIL
HEADQUARTERS**

Kilkis Industrial Area
Kilkis - GR 61100
TEL.: +30 23410 79300
FAX.: +30 23410 71988
E-MAIL.: info@alumil.com



**ALUMIL
HEAD OFFICES
& SHOWROOM - THESSALONIKI**

GOGOUSI 8, EFKARPIA
THESSALONIKI - GR 56429

TEL.: +30 2313 011000
FAX.: +30 2310 692473
EMAIL.: info@alumil.com

**ALUMIL
HEADQUARTERS**

KILKIS INDUSTRIAL AREA
KILKIS - GR 61100

TEL.: +30 23410 79300
FAX.: +30 23410 71988
EMAIL.: info@alumil.com

www.alumil.com

The ALUMIL logo is displayed in white on a dark blue background. It features a stylized 'A' symbol followed by the word 'alumil' in a lowercase, sans-serif font. A small yellow square is positioned above the 'i' in 'alumil'.

alumil