



Alumil
Building excellence every day

Alumil  **SUPREME**
S700



CONTENTS

SUPREME S700

DESIGN PHILOSOPHY & CHARACTERISTICS	4
SENSE OF FREEDOM	8
ATTENTION TO DETAIL	12
ATTENTION TO ENERGY EFFICIENCY	16
ATTENTION TO SAFETY	18
SECTIONS	20

SUPREME S700 ECLIPSE

THE MINIMAL TOUCH	34
SECTIONS	38

INSTALLATION	42
APPLICATIONS	46
TABLE OF PERFORMANCE	48
REFERENCE PROJECTS	50



SUPREME S700

The SUPREME S700 Lift & Slide system represents the evolution of ALUMIL's advanced systems for projects with wide spans and impressive features. The system complies perfectly with the modern trends of transparent architecture, combining high thermal insulation, safety and modern design.

Durability at another level

Alumil SUPREME
S700

The combination of
transparent architecture
and **high energy efficiency**

The system's **minimal design**, along
with the state-of-the-art technology,

DESIGN PHILOSOPHY

make it the **ideal solution** for projects aimed to
enhance **natural lighting**, satisfying even the
most demanding requirements.

@ CHARACTERISTICS

- Basic system's depth 70 mm.
- Interlocking face width of only 47 mm for maximum visibility and reinforced profiles for door height of more than 3 m.
- Innovative low threshold for easy access and high performance.
- Alternative solution for totally concealed in-floor installation, covered with the floor finish (SUPREME S700 Eclipse version).
- High energy efficiency with special anti-distortion polyamides for improved performance, in case of high-temperature differences between indoors and outdoors.
- Smart water evacuation system that guarantees watertightness under any weather condition.



Alumil SUPREME
S700

TECHNICAL

CHARACTERISTICS



VISIBLE ALUMINIUM FACE WIDTH	115 mm
FRAME HEIGHT	24 / 48 mm
FRAME WIDTH	168,5 mm
SASH HEIGHT	84 / 95,5 mm
SASH WIDTH	70 mm
INTERLOCKING PROFILE WIDTH	47 / 106 mm
SASH WEIGHT	UP TO 600 kg
GLAZING	22 UP TO 50 mm
INSULATION	POLYAMIDES, PVC, NRG BARS, INSULATION FOAM

The perfect combination of **elegance** and **functionality**, SUPREME S700 satisfies even the most demanding requirements.

SENSE

OF FREEDOM

ALTERNATIVE VERSION WITH LOW THRESHOLD:

A flat track that ensures easy and safe access to children, the elderly and people with disabilities. A more flexible solution with innovative water drainage, ideal for renovations.



LOW THRESHOLD



STANDARD THRESHOLD

Alumil SUPREME
S700

Elegant appearance
minimizing the visible
aluminium frame...

by using the narrow interlocking
profile of only **47 mm!**

SENSE

OF FREEDOM

The alternative **narrow reinforced profile** with an
integrated handle offers **higher resistance to wind
loads** for frames of more than 3 m in height.



Alumil SUPREME
S700

ATTENTION

Special **anti-distortion polyamides** that minimize potential malfunctions caused by high-temperature fluctuations.

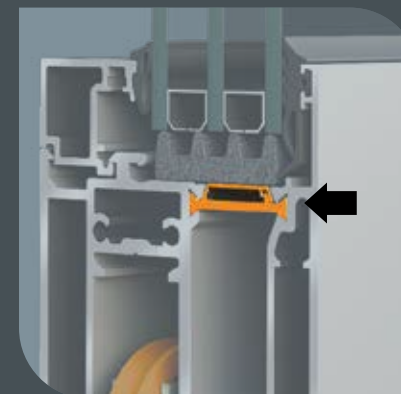

Thermal insulation is enhanced by the **PVC profiles with UV protection**, which preserves their durability and texture under intense exposure to solar radiation.

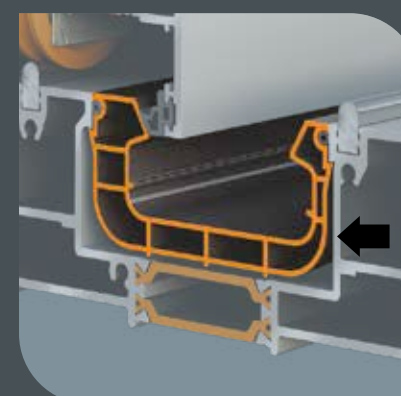

High-quality EPDM gaskets perimetrically of the sash contribute significantly to the system's overall performance.



The special design of aluminium **glazing support** transfers loads directly to the rollers, maximizing the **smooth glide** of the sliding sashes.



TO DETAIL

The insulation foam perimetrically of the glazing unit ensures proper ventilation while the **NRG bars** significantly boost the system's **thermal insulation**.

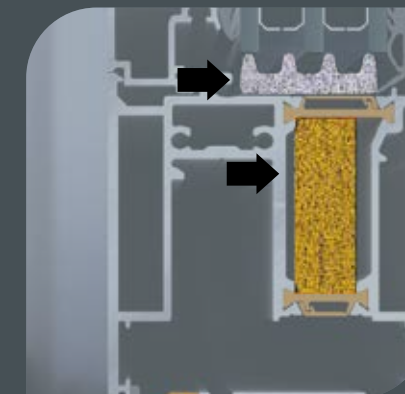

The specially designed **PVC profiles** for the narrow interlocking profile optimize **air permeability** and **thermal insulation**, enhancing energy saving.

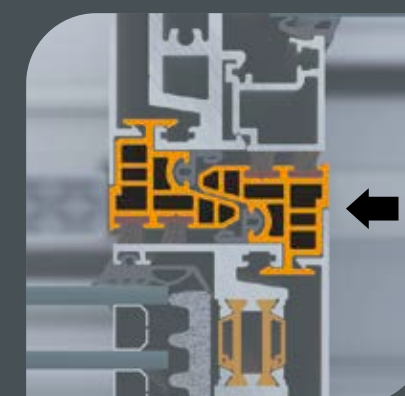

Specially designed sash gaskets for low track **combine EPDM with foam EPDM** to offer improved sealing performance.

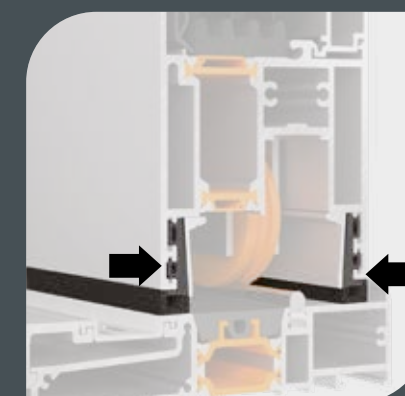

The door sashes **glide easily and quietly on solid rails** made of AISI 316L stainless steel.

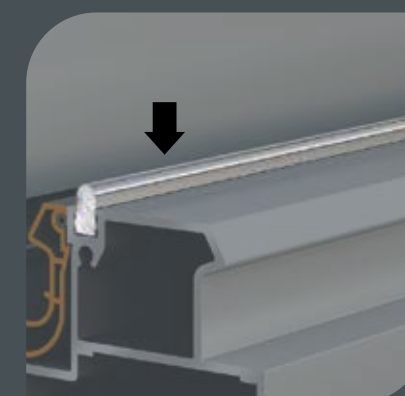

The innovative and **patented design** of the advanced water drainage system...

offers **excellent performance** even under adverse weather conditions.

ATTENTION

TO DETAIL



- Smart water drainage system even under severe weather conditions.



- Special patented central seal offering a high level of watertightness.



- Concealed water drainage due to the unique design of the low threshold.



- Specially perforated profiles allowing the water to flow through to its way out.



ATTENTION

TO ENERGY EFFICIENCY

There are **3 different sash** designs available to meet every demand for energy-saving specifications.

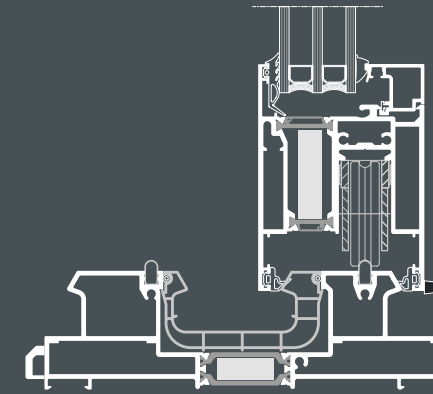

Sash S70706

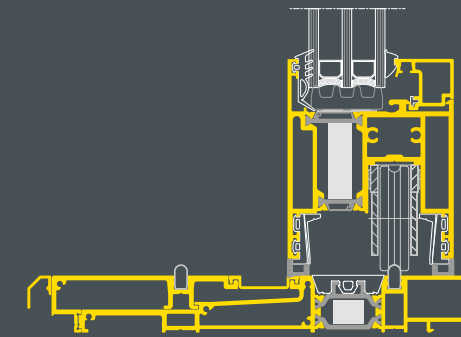

Sash S70710

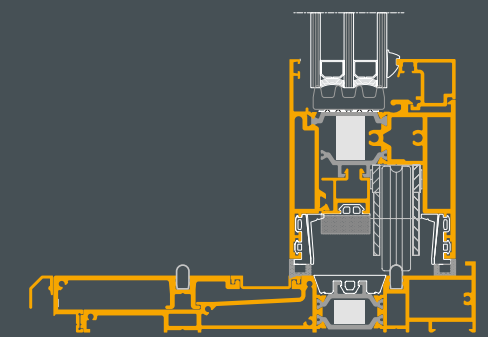

Sash S70776

SASH	S70706	S70710	S70776
THERMAL VARIANTS			
NRG BARS	●	●	●
EPDM FOAM SASH GASKETS		●	●
EPDM FOAM INFILLS			●
SASH PVC PROFILES			●
POLYAMIDES	24 & 18,6 mm	24 & 18,6 mm	32 & 28 mm
PERFORMANCE			
U _f	2,8	2,8	2,3

Alumil SUPREME
S700

ATTENTION

TO SAFETY

Lift & Slide mechanism

SUPREME S700 is ideal for heavy-duty constructions cooperating with the Lift & Slide mechanism which offers:

- Outstandingly smooth and quiet movement of the sliding sashes.
- High anti-burglary protection thanks to robust hardware components.
- Easy operation even of large and heavy sashes.
- Cooperation with silent close accessory for the sash to close softly and safely.
- Compatibility with an automated mechanism for 1 sash / 1 fixed typology.



Handles

The system is accompanied by branded Lift & Slide handles designed by ALUMIL and manufactured by world-class specialists to ensure top quality and flawless operation. They are made of aluminium and are available in various standard colours.

2 Sashes / 2 Track

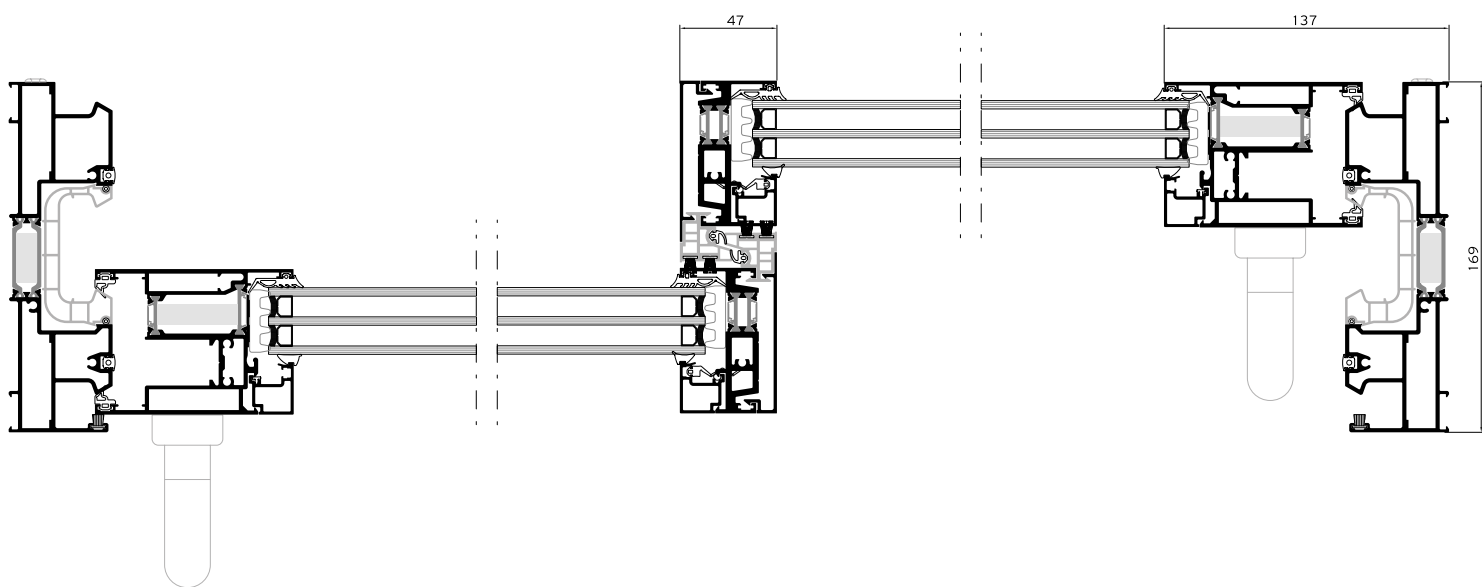
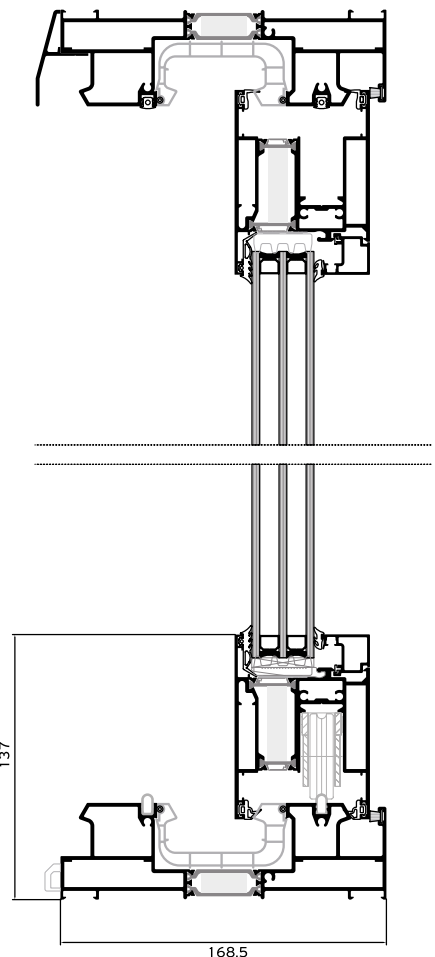
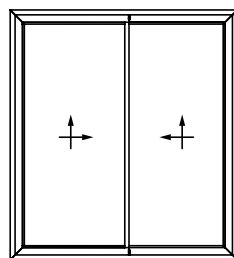

2 Sashes / 2 Track Low Threshold

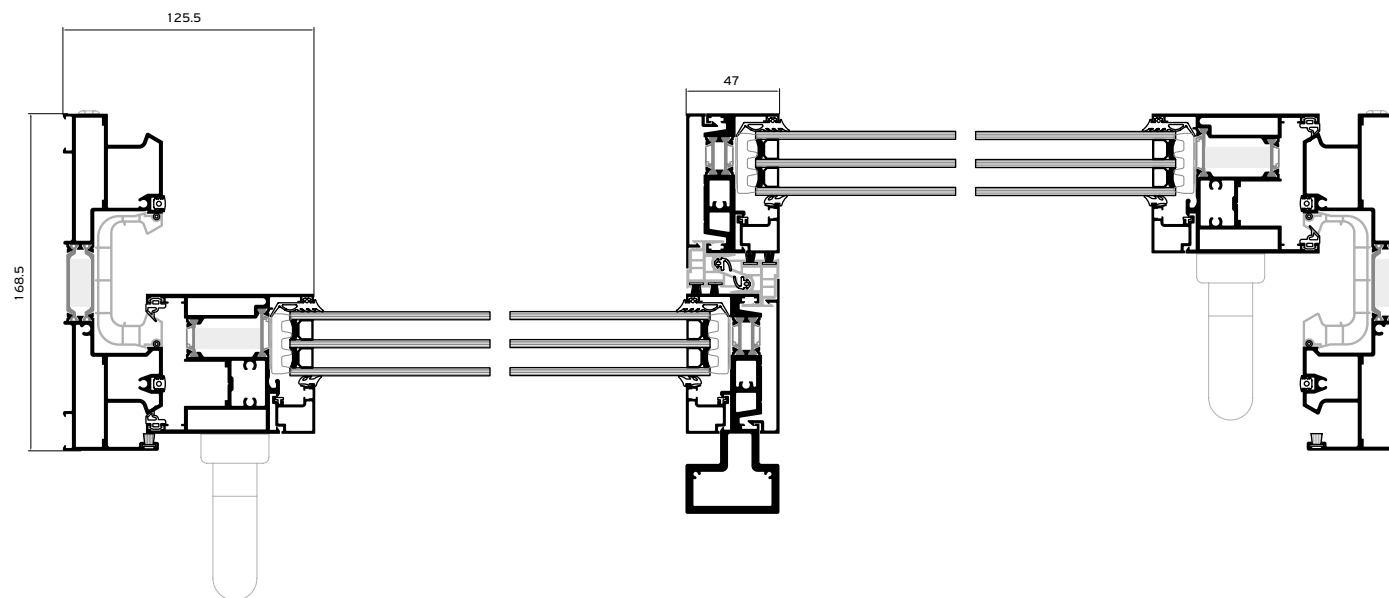
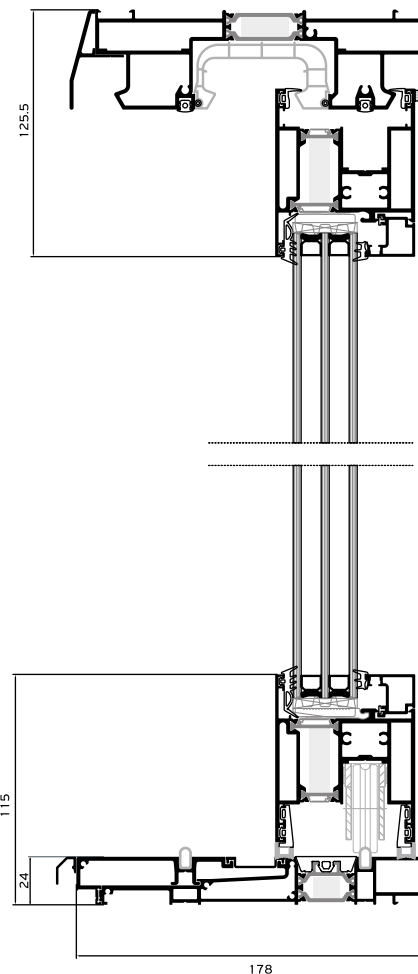
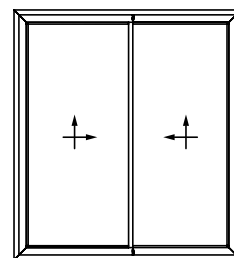

2 Sashes / 2 Track / Flyscreen

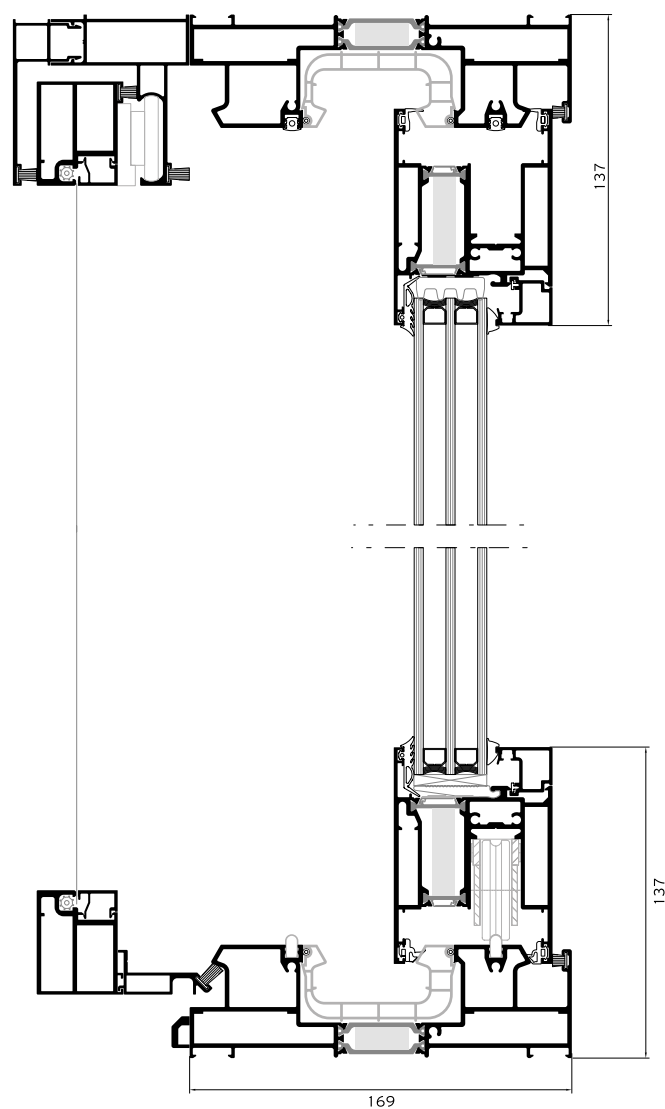
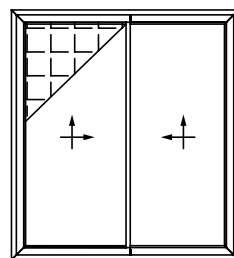

2 Sashes / 2 Track / Flyscreen Low Threshold

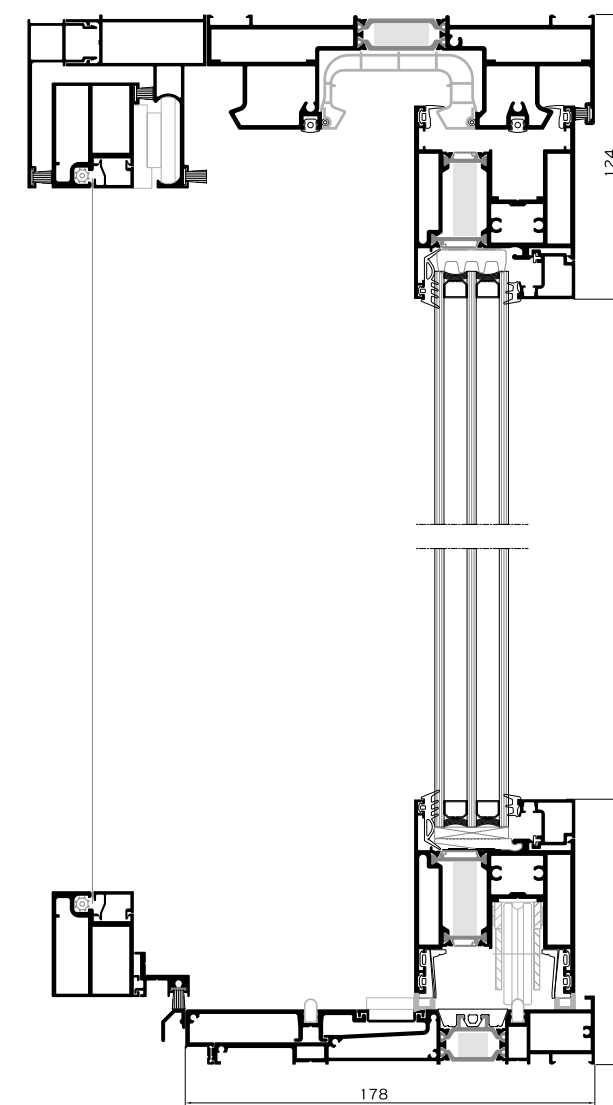
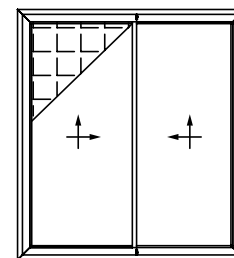

3 Sashes / 3 Track

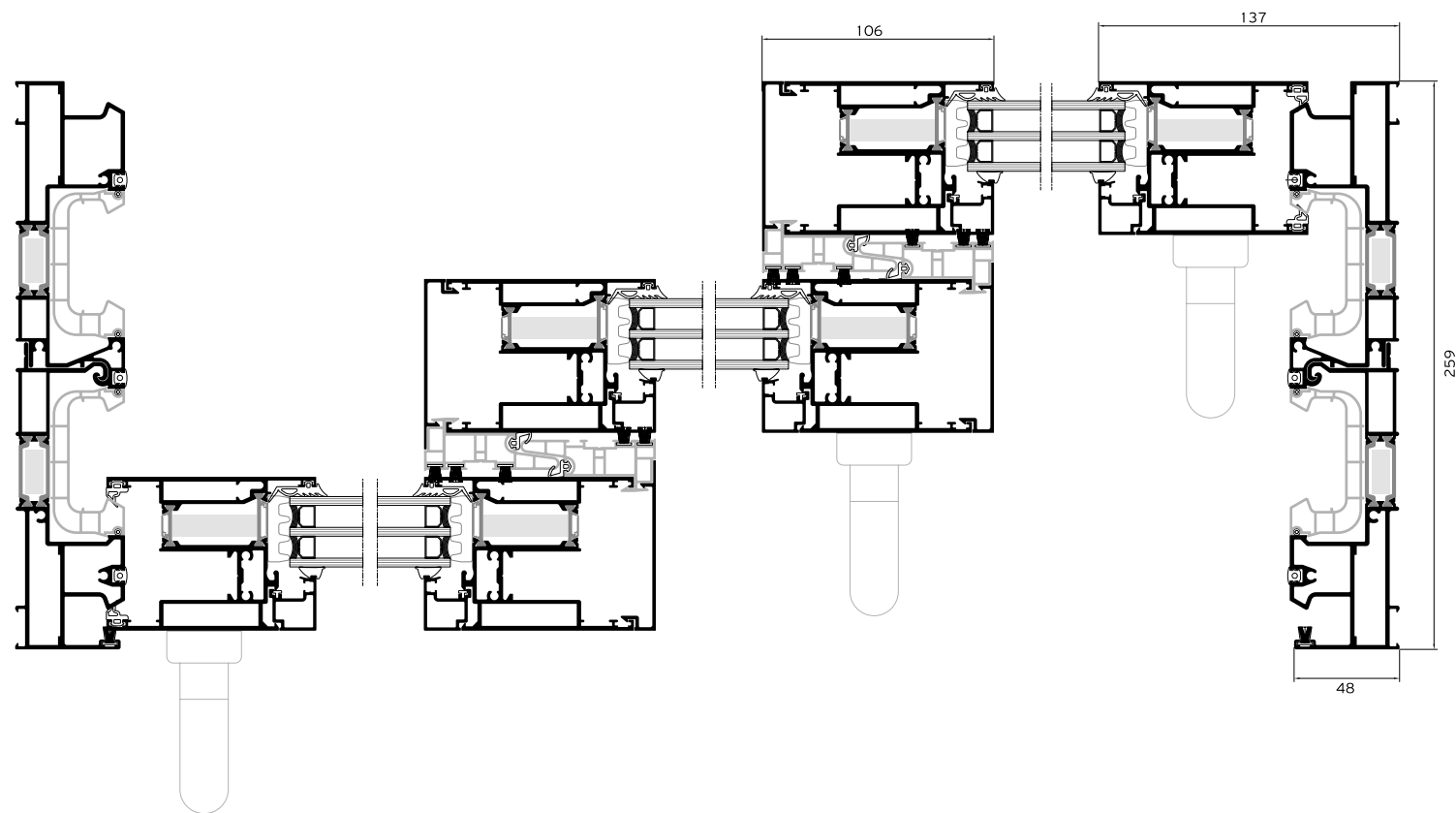
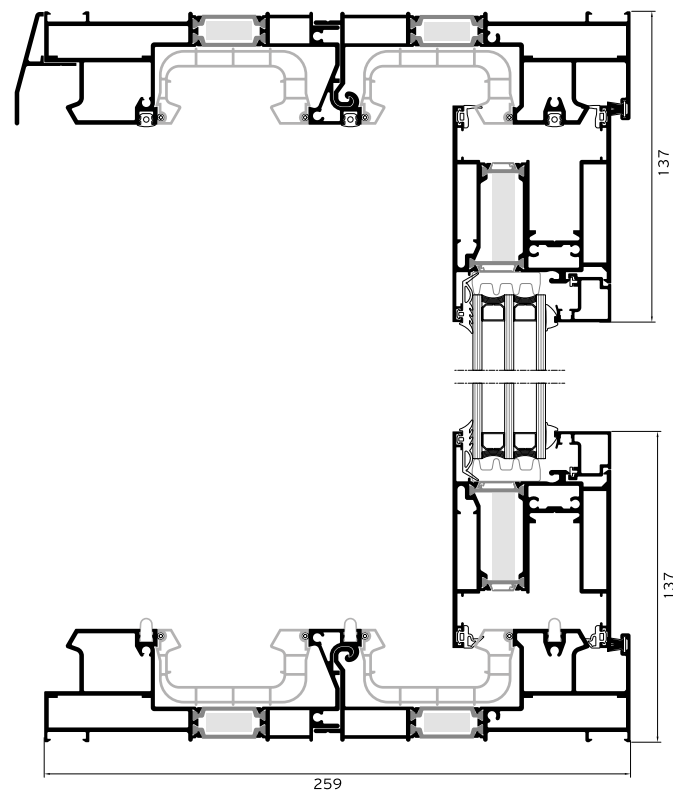
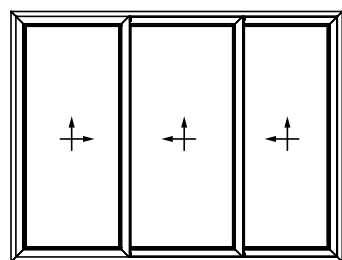

3 Sashes / 3 Track Low Threshold

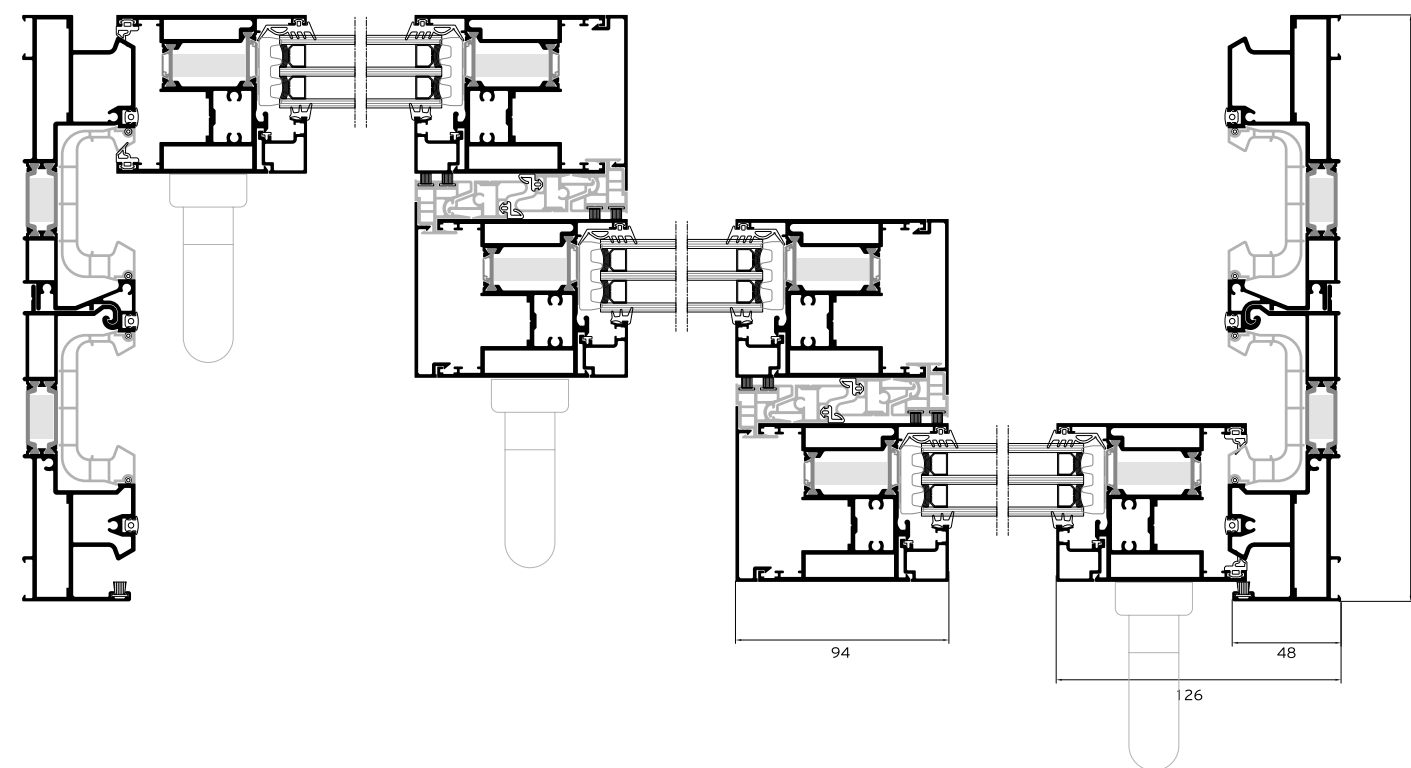
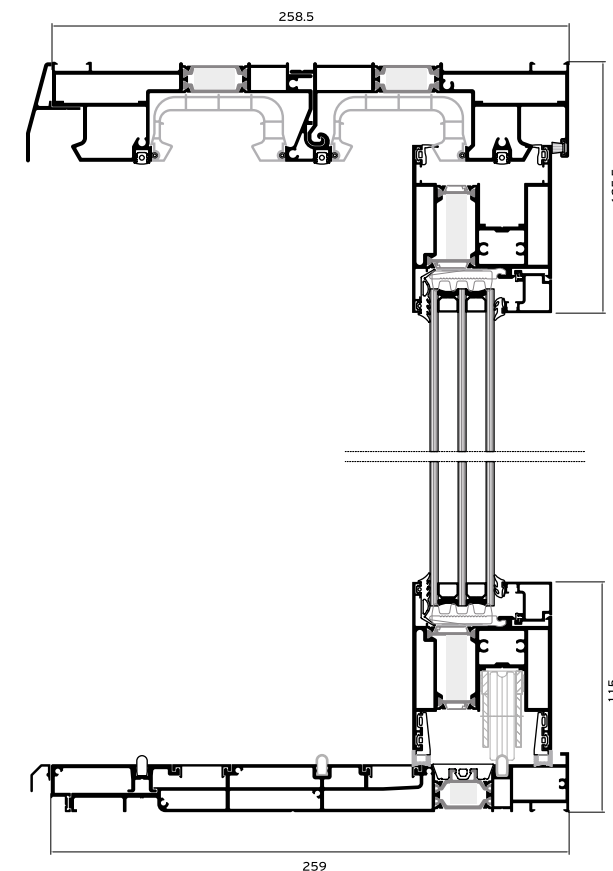
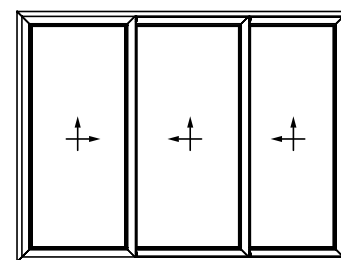

Alumil SUPREME
S700

4 Sashes / 2 Track

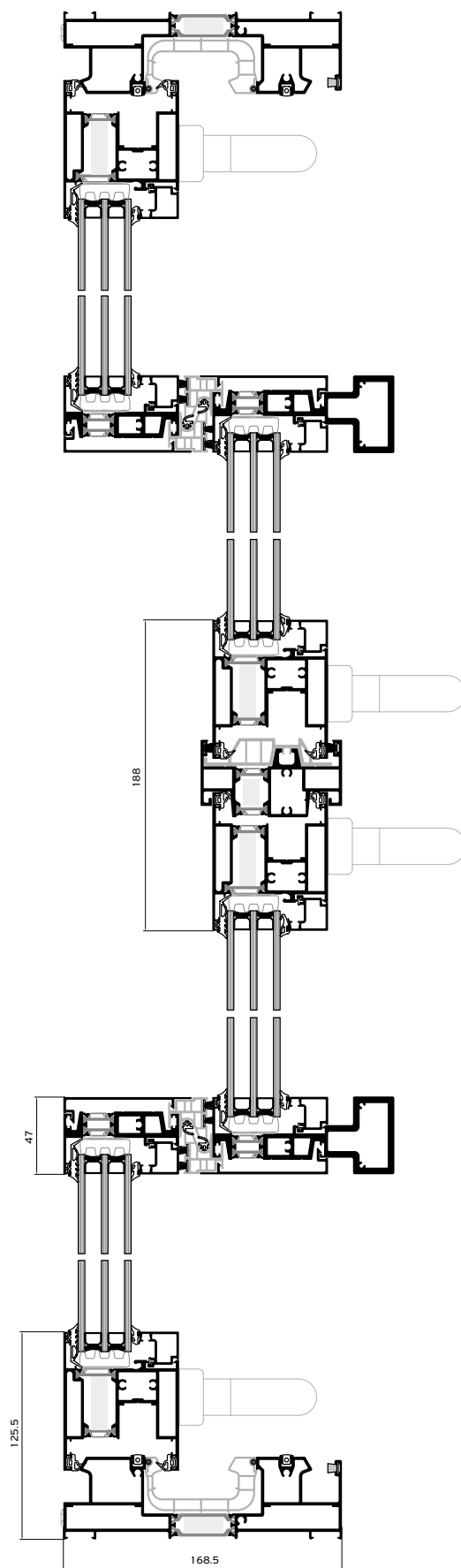
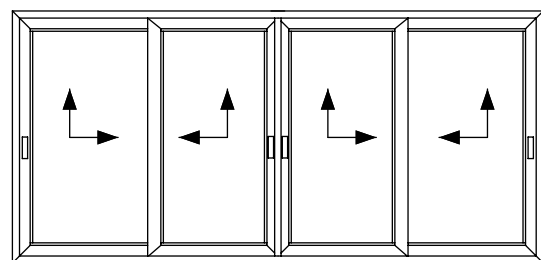

MULTI TRACK

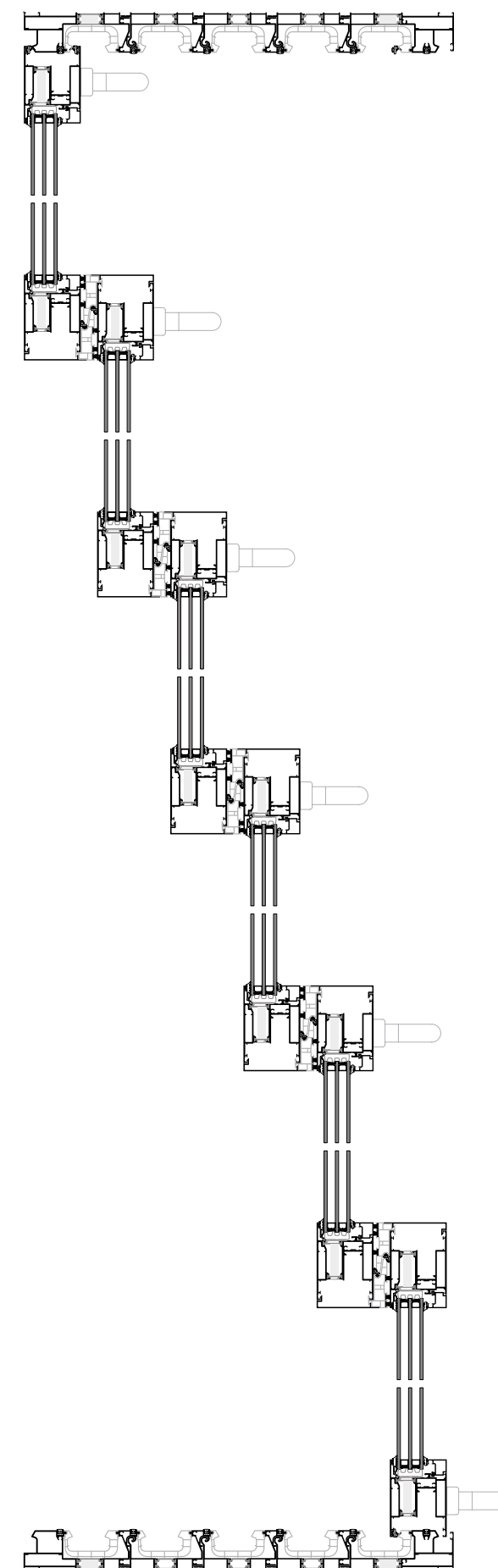
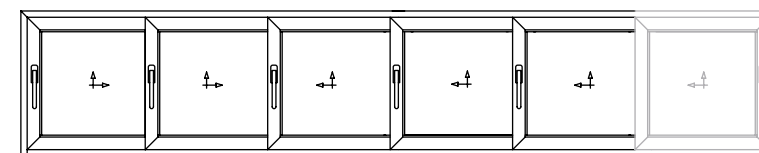

EXTERNAL CORNER

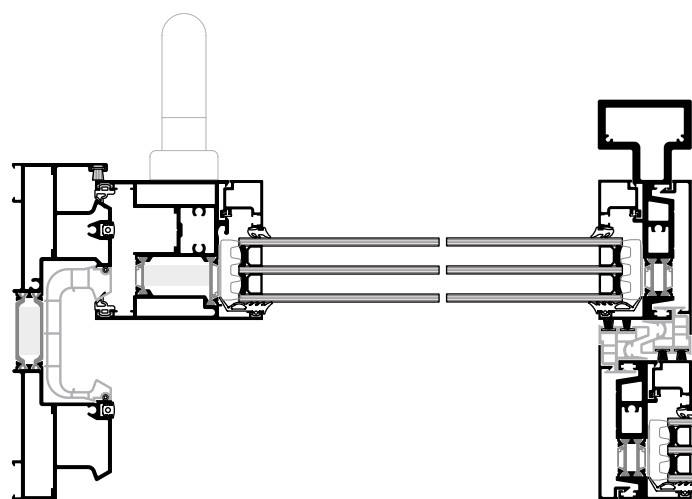
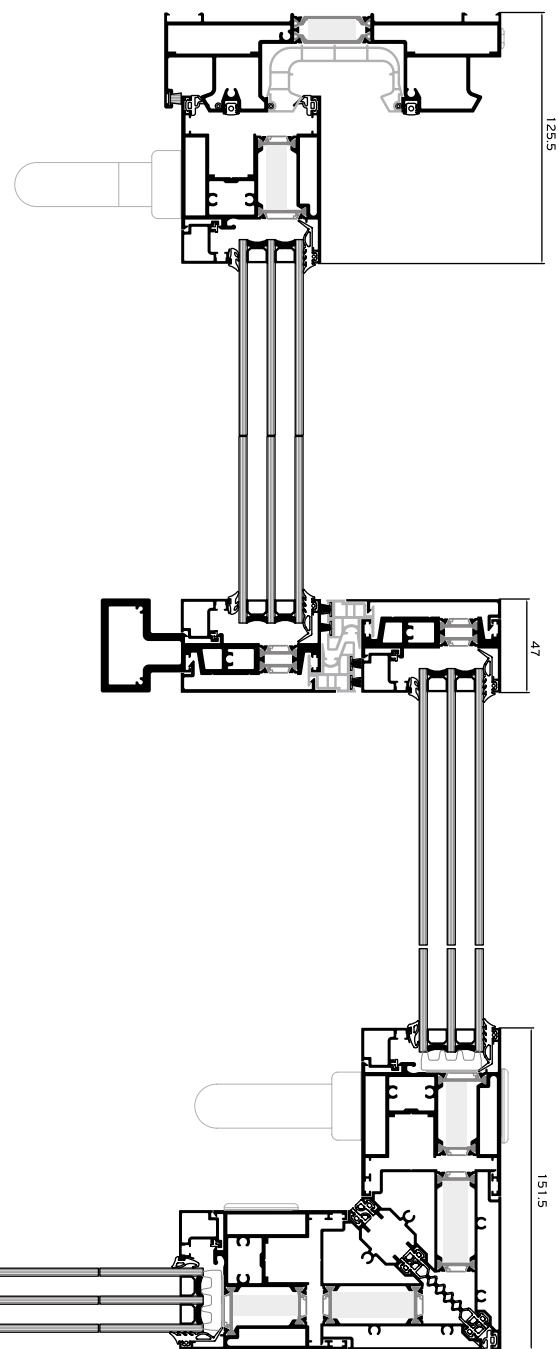
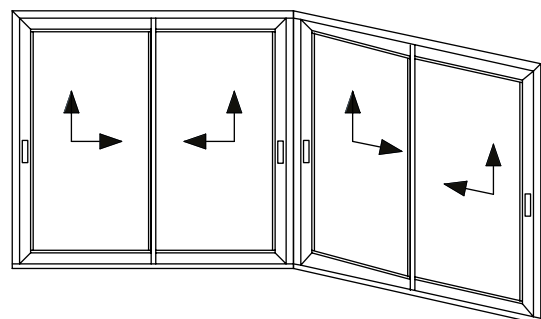

1 Sash / Fixed light

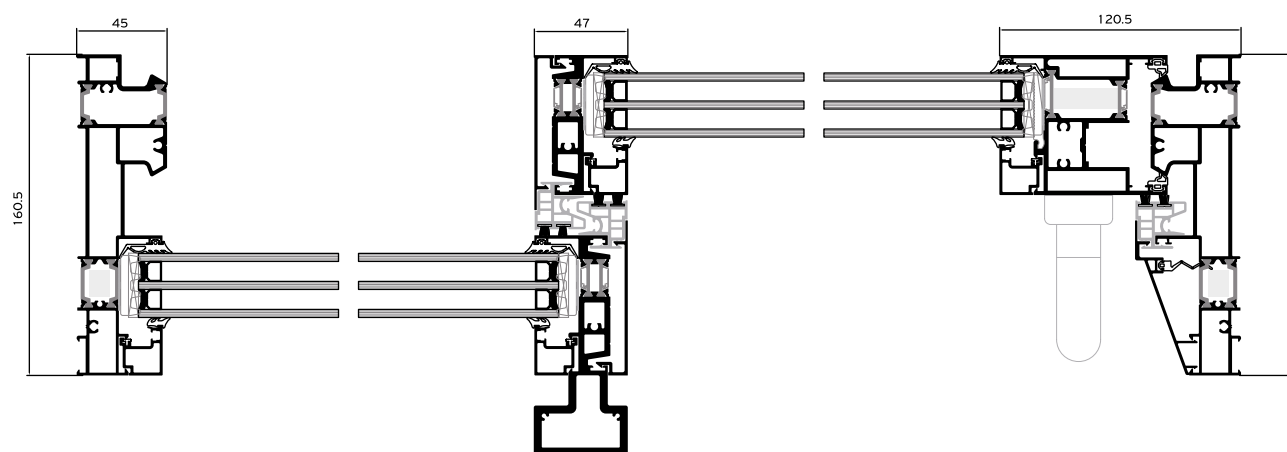
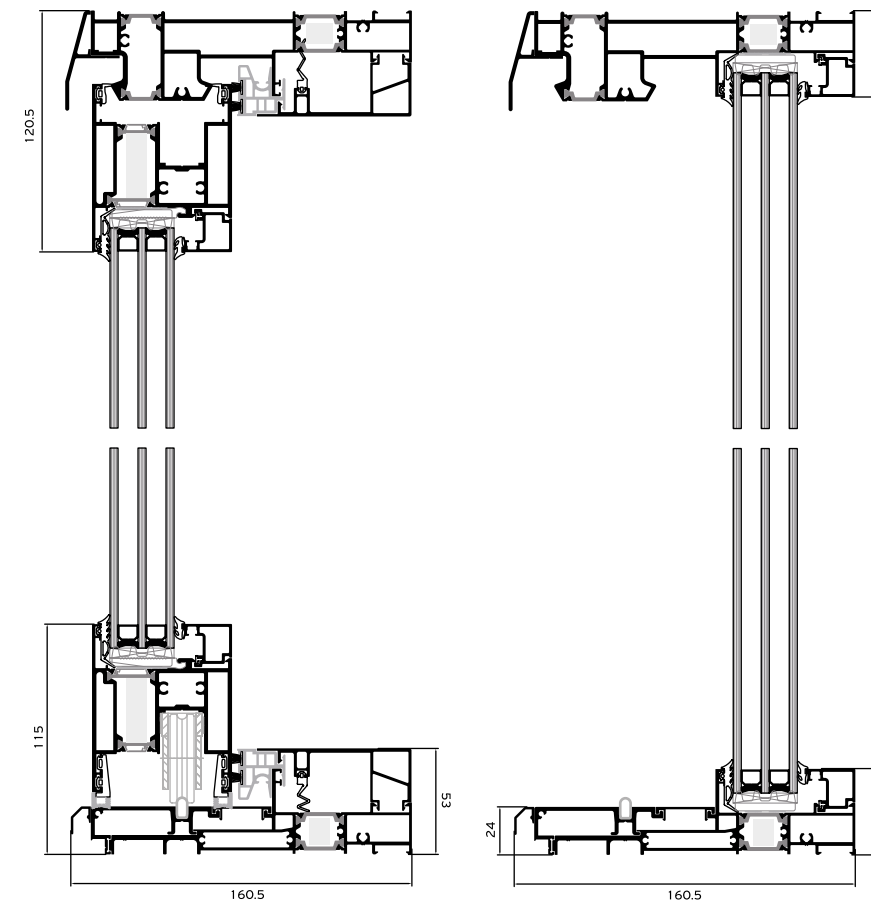
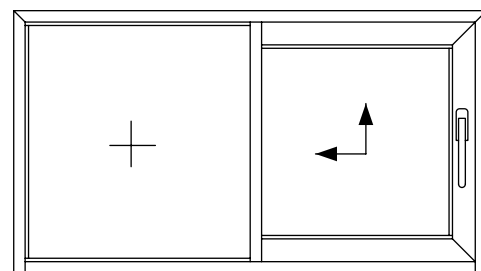

1 Sash / Fixed light / 1 Sash

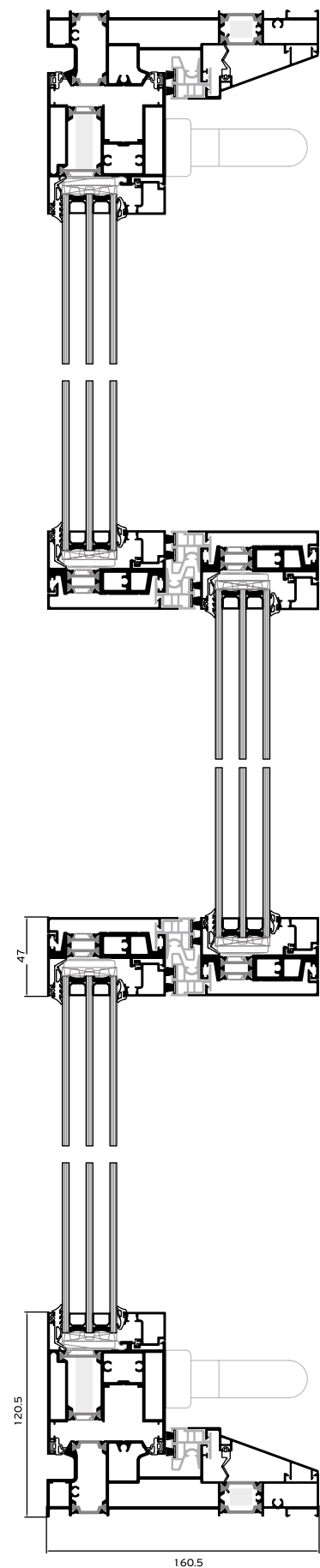
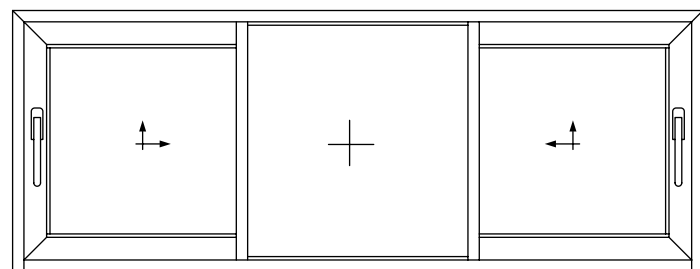

Fixed light / 1 Sash / Fixed light

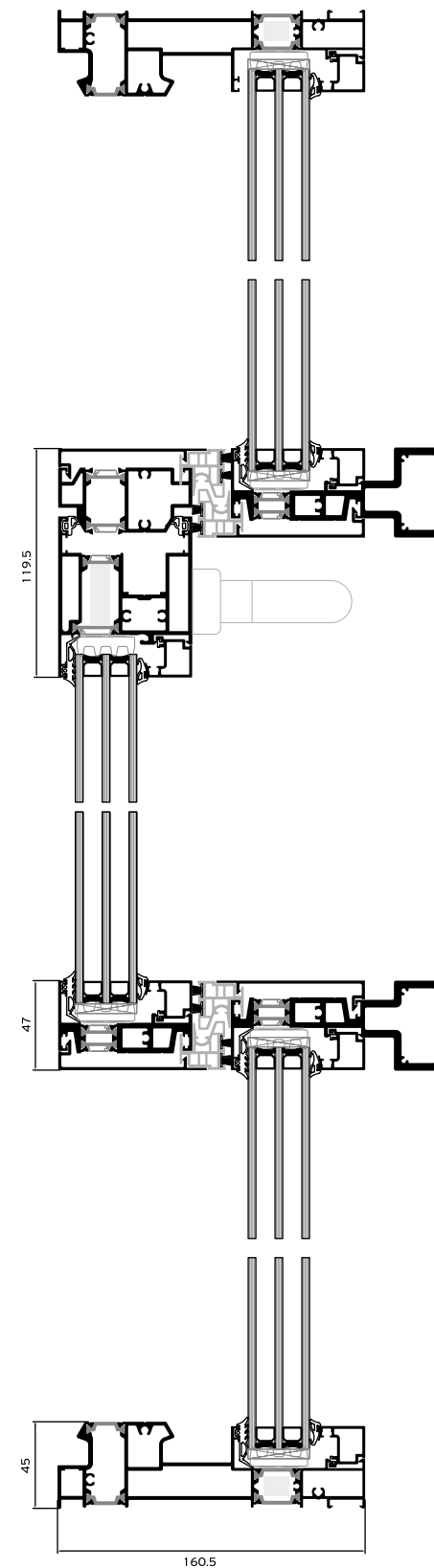
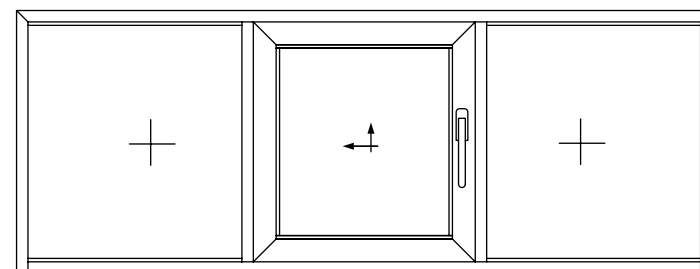

POCKET WINDOW

1 Sash / Flyscreen / Shutter

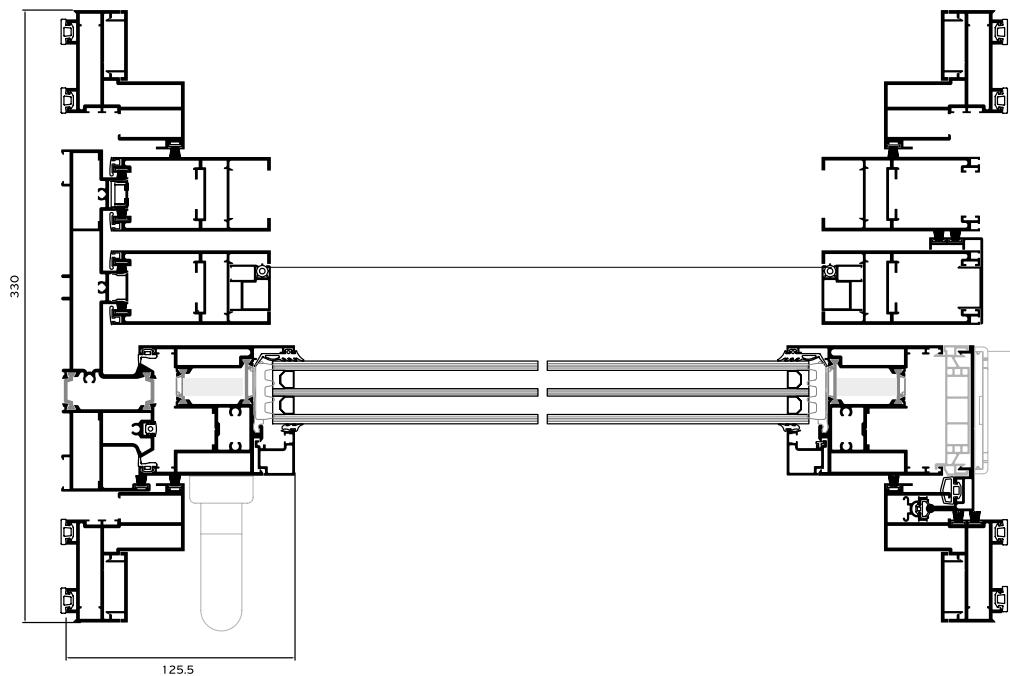
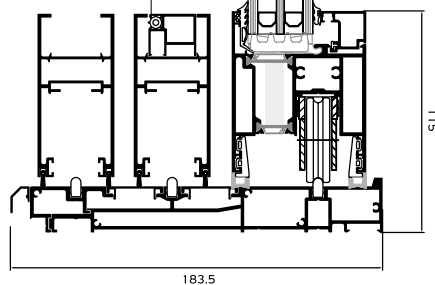
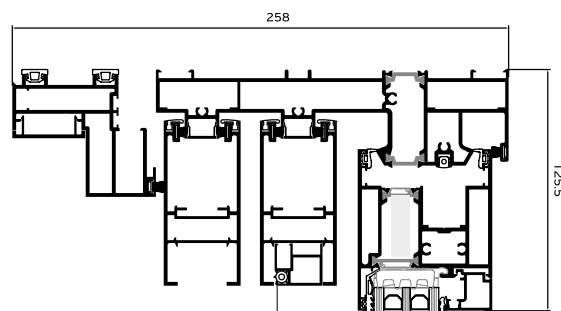
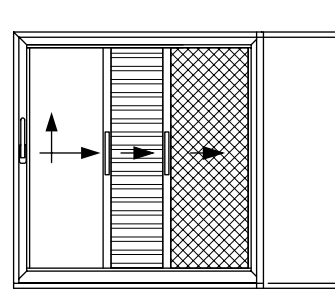

POCKET WINDOW

2 Sashes / Flyscreen / Shutter

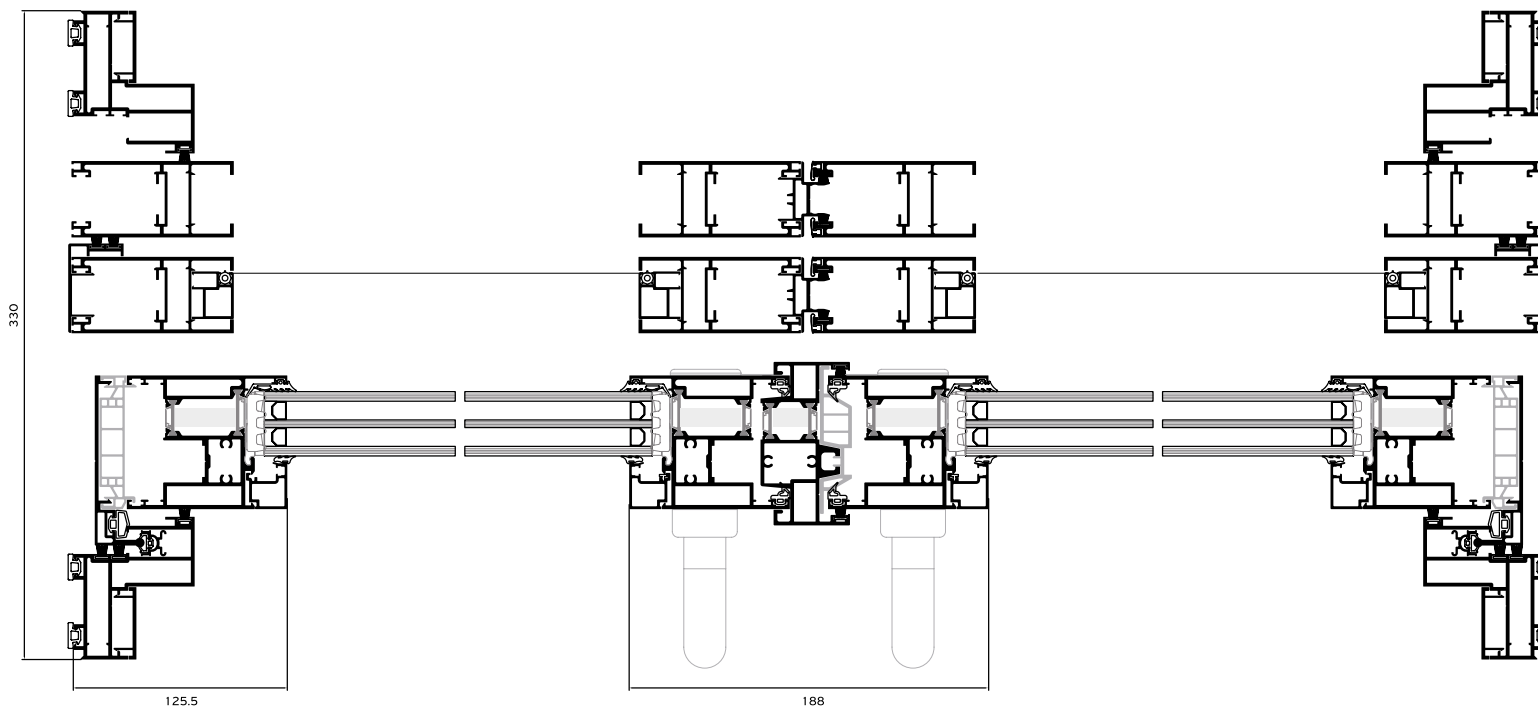
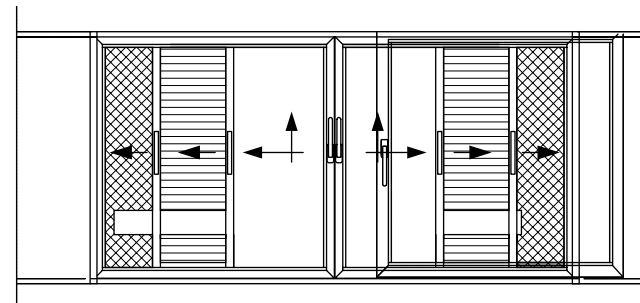

Alumil SUPREME
S700 ECLIPSE

SUPREME S700 Eclipse
is totally **integrated into**
the floor...

and covered with the floor finish, creating a flat
surface and **a sense of continuity between the**
interior and the exterior environment.

THE MINIMAL

TOUCH



- Invisible bottom track totally flush to the floor.
- Only 47 mm visible aluminium face width at the interlocking profile.
- Totally concealed water drainage with high performance.
- Meets architectural requirements for easy and safe access.
- Smooth and noiseless operation due to the Lift & Slide mechanism.

Alumil SUPREME
S700 ECLIPSE

TECHNICAL

CHARACTERISTICS



VISIBLE ALUMINIUM FACE WIDTH	91 mm
FRAME HEIGHT	64 mm
FRAME WIDTH	217,3 mm
SASH HEIGHT	84 mm
SASH WIDTH	70 mm
INTERLOCKING PROFILE WIDTH	47 / 94 mm
SASH WEIGHT	UP TO 600 kg
GLAZING	22 UP TO 50 mm
INSULATION	POLYAMIDES, PVC, NRG BARS, INSULATION FOAM

2 Sashes / 2 Track

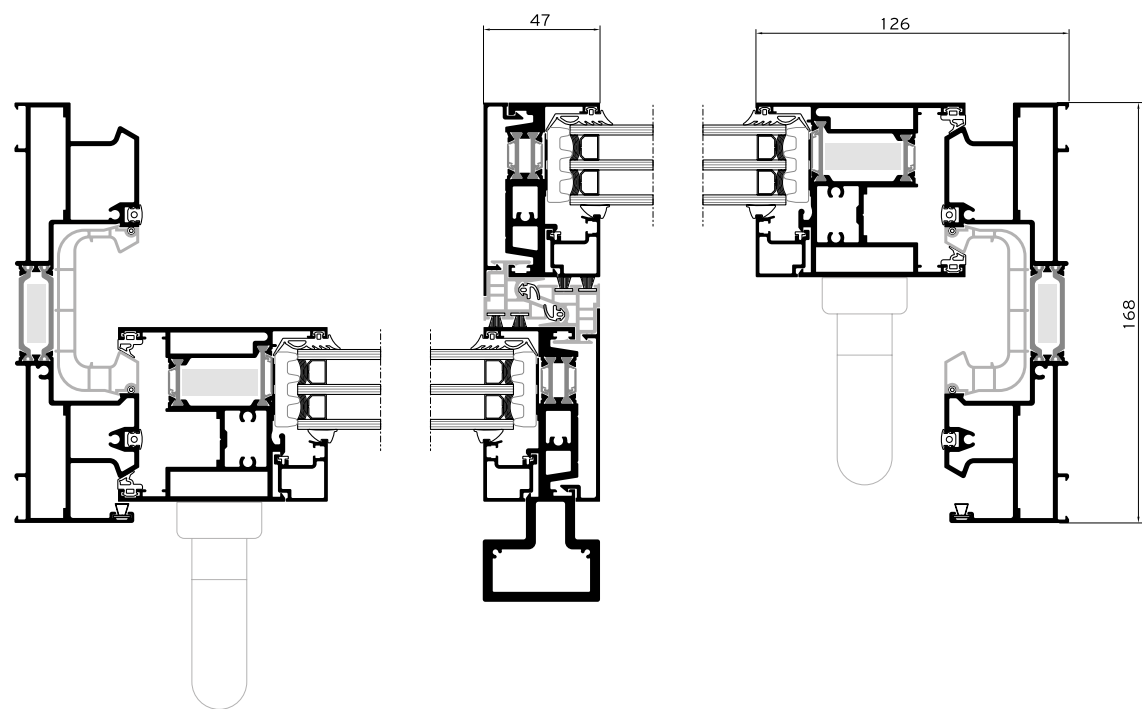
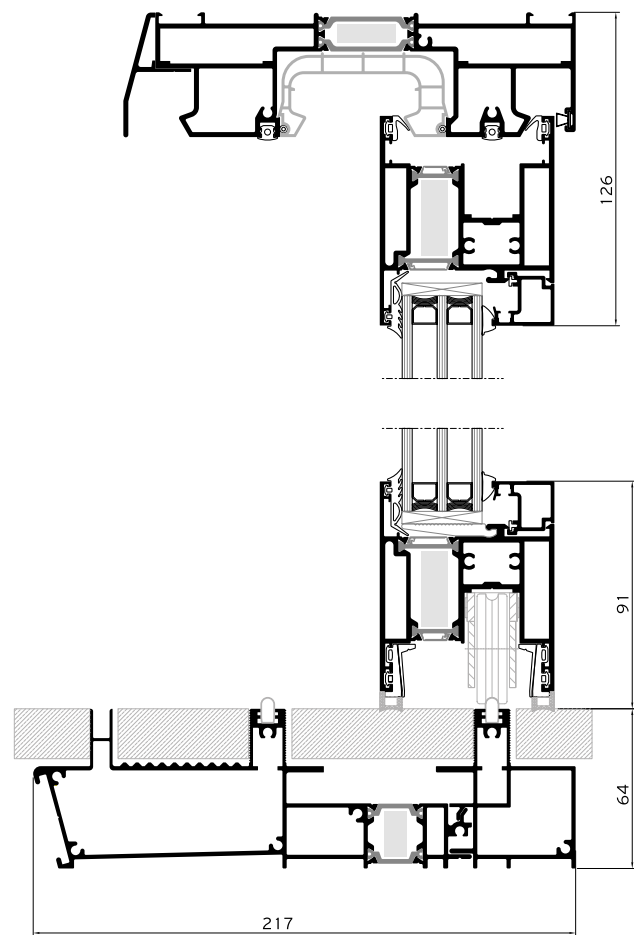
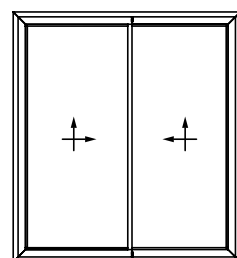

2 Sashes / 2 Track / Flyscreen

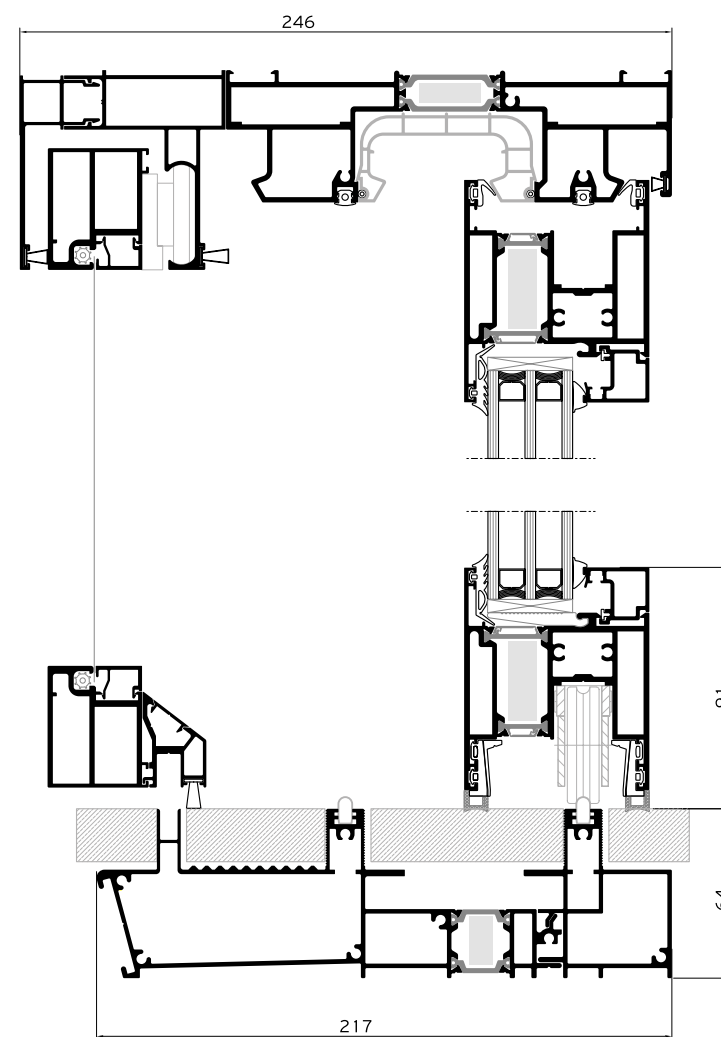
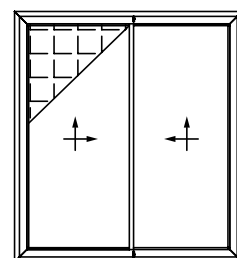

3 Sashes / 3 Track

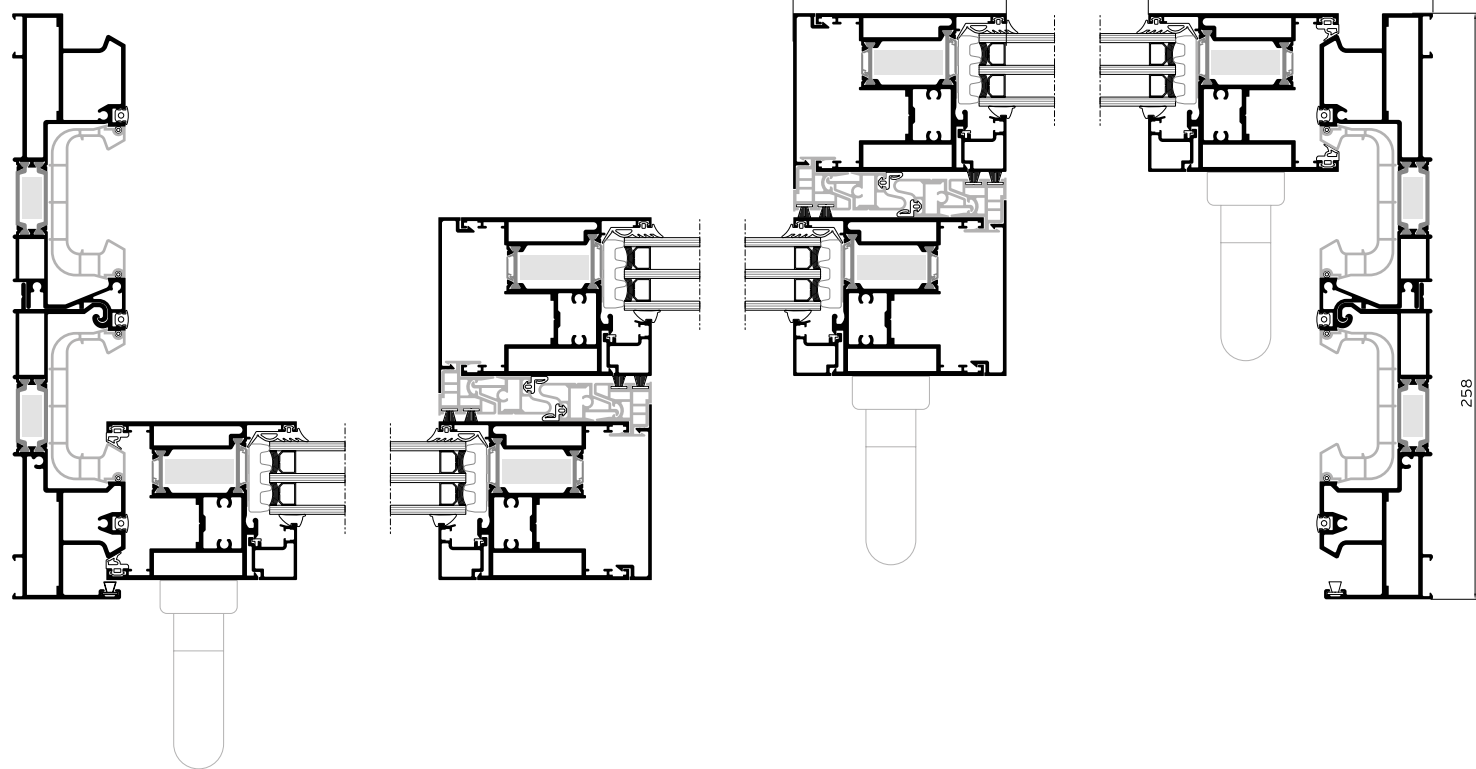
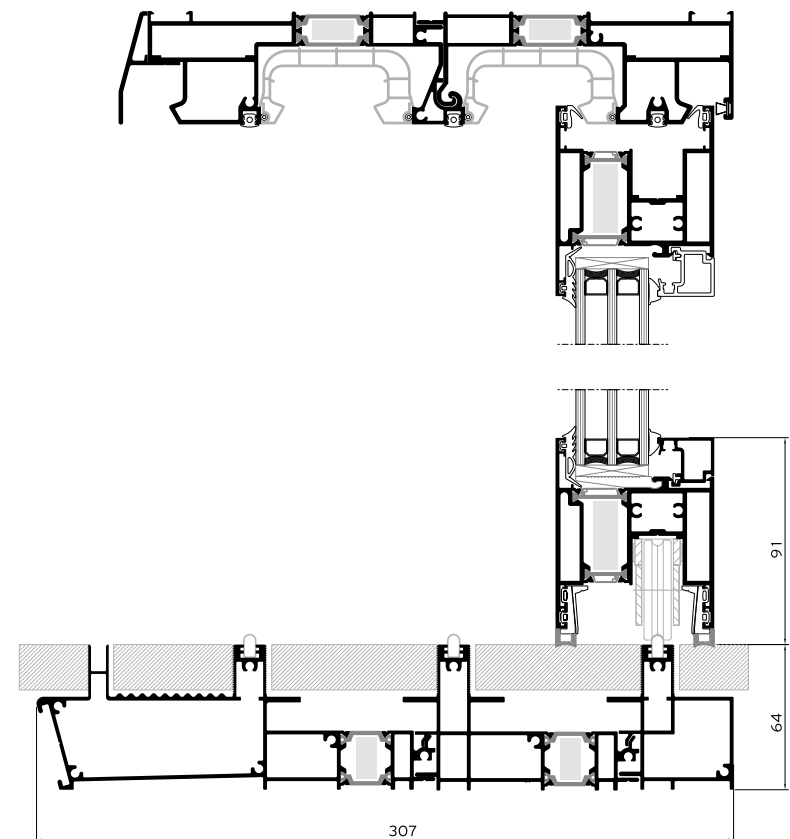
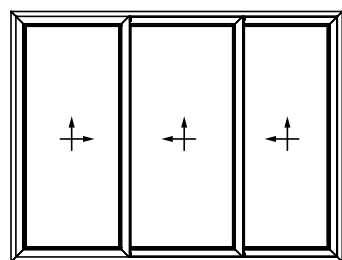



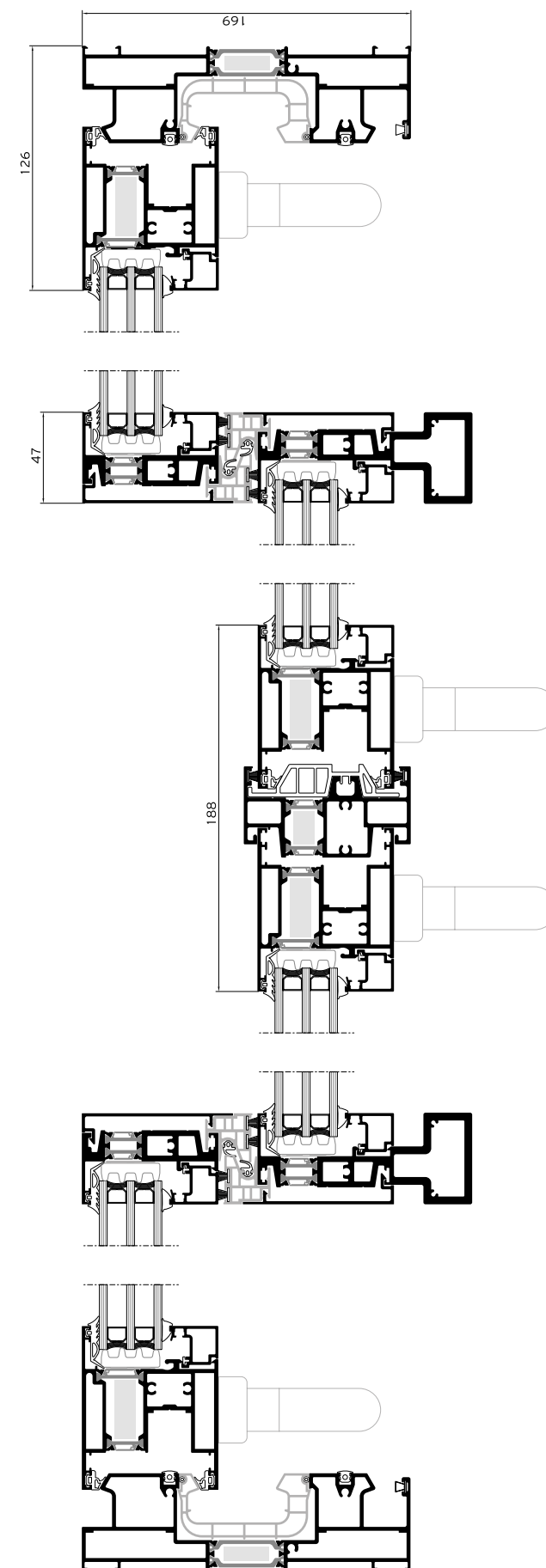
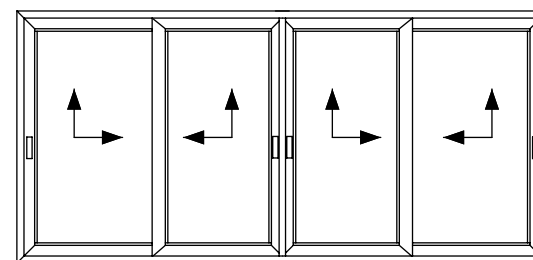







4 Sashes / 2 Track



Installation

SIDE & TOP SECTION

-  PRECOMPRESSED MULTI-FUNCTION SEALING TAPE
-  BACKER ROD
-  HYBRID SEALANT OR NEUTRAL SILICONE
-  STYRODUR HIGH DENSITY BOARD
-  MARBLE
-  POLYURETHANE FOAM
-  POLYSTYRENE
-  WALL CONSTRUCTION
-  WALL FINISH
-  REINFORCED CONCRETE
-  AIR WATER VAPOR BARRIER TAPE

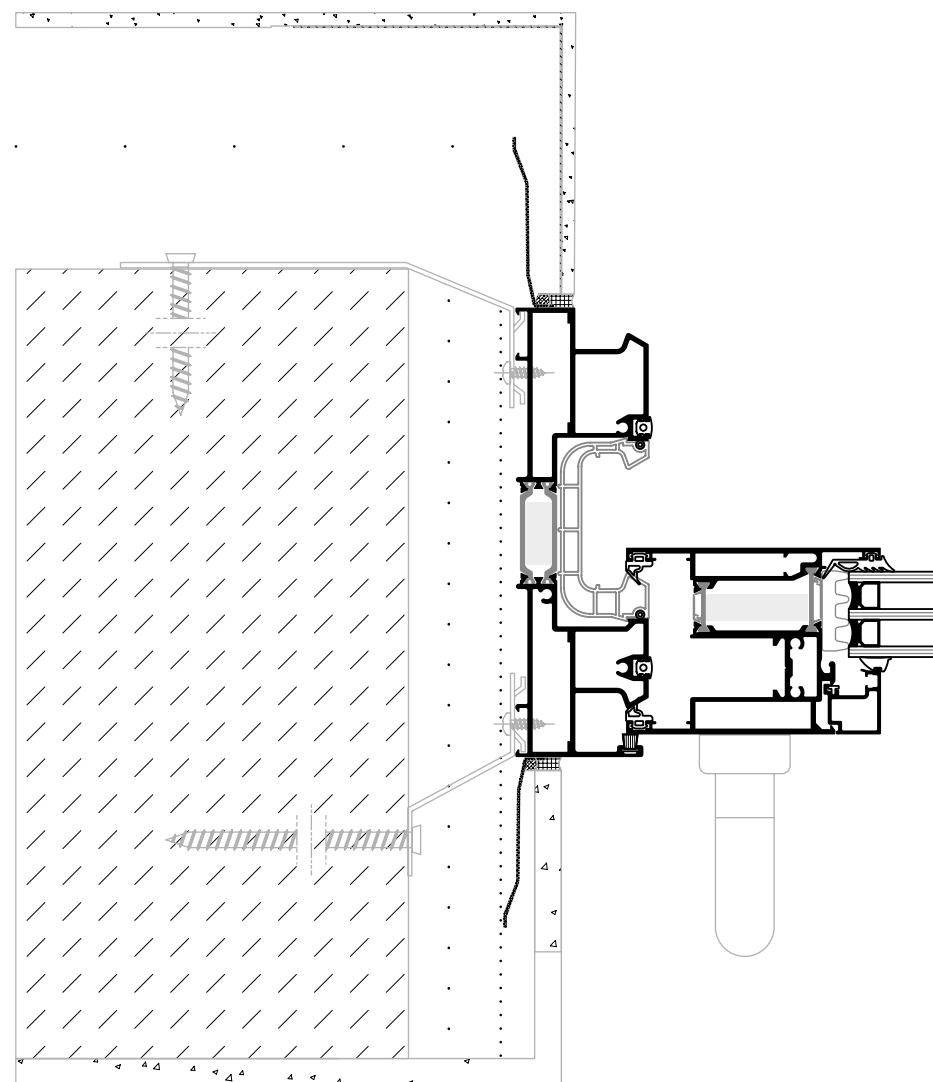

BOTTOM SECTION (STANDARD TRACK)

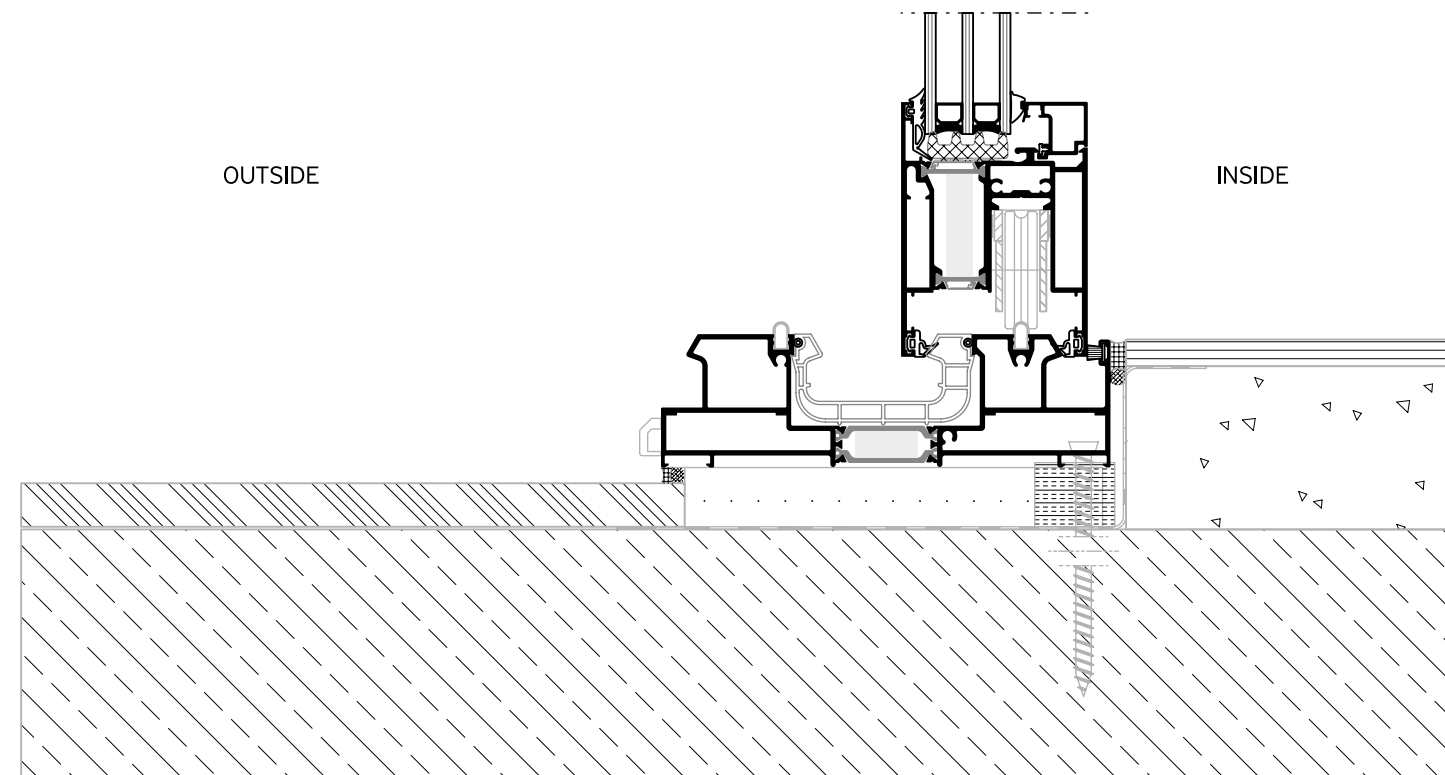

Installation

BOTTOM SECTION (LOW TRACK)

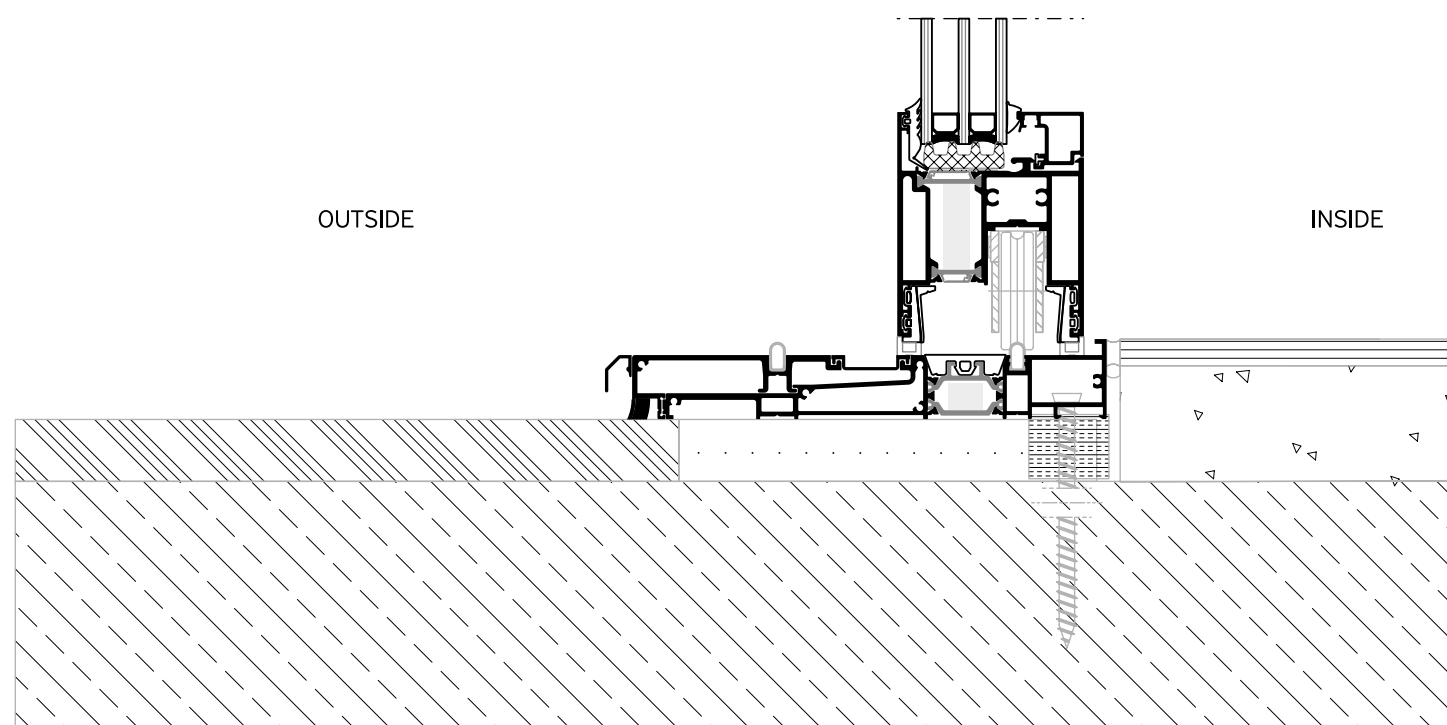

BOTTOM SECTION (ECLIPSE TRACK)

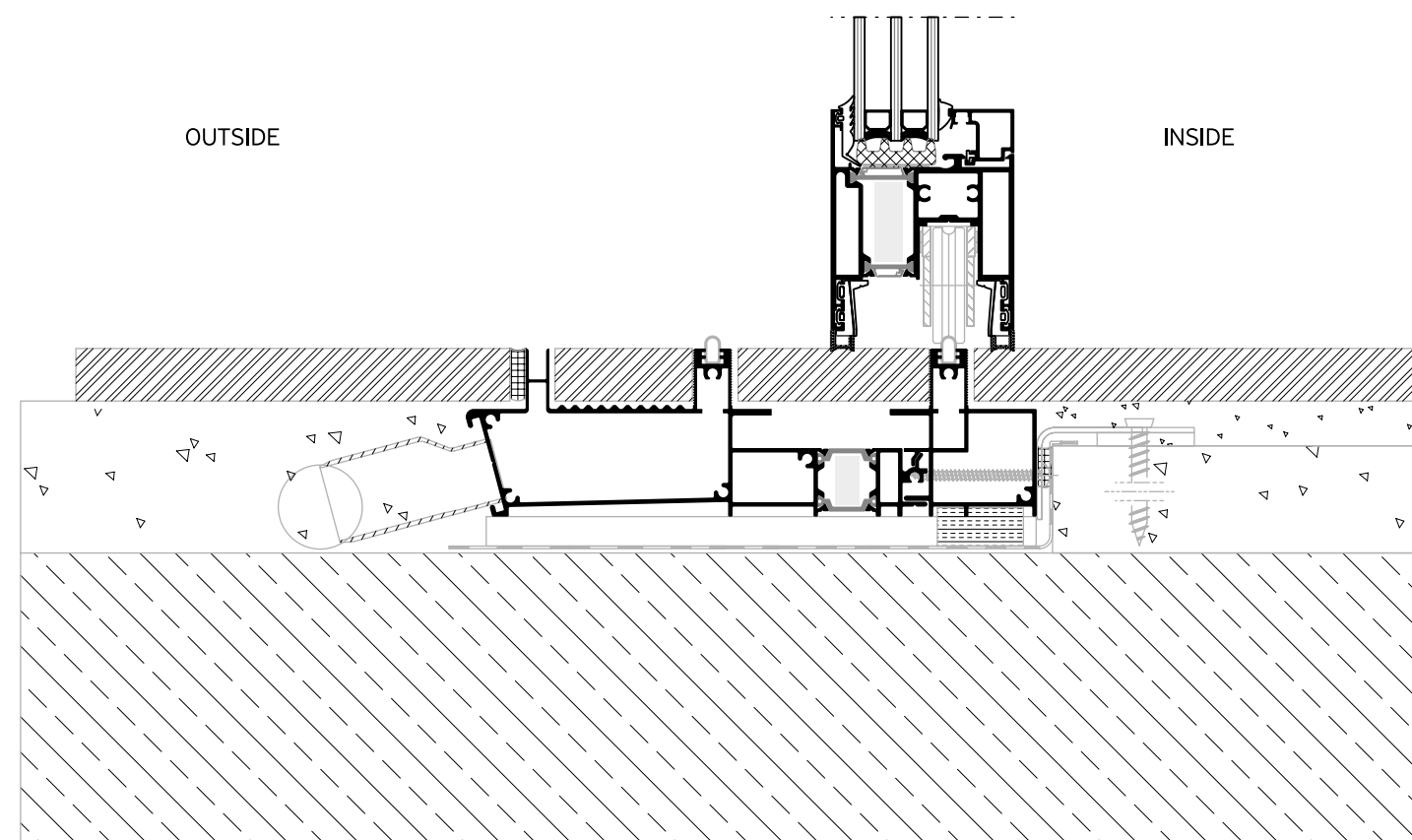

Applications

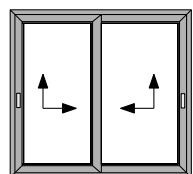

2 SASHES / 2 TRACK

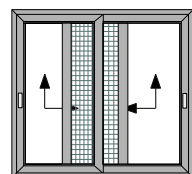

2 SASHES / 2 TRACK /
FLYSCREEN

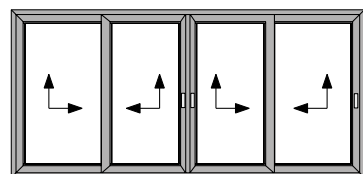

4 SASHES / 2 TRACK

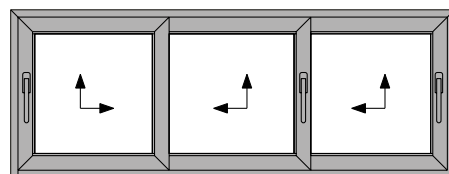

3 SASHES / 3 TRACK

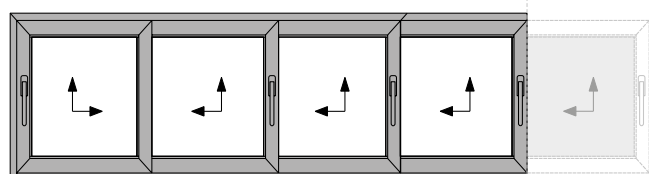

MULTI TRACK

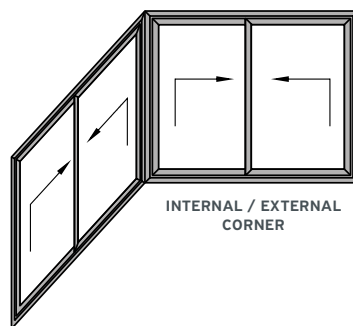

INTERNAL / EXTERNAL
CORNER

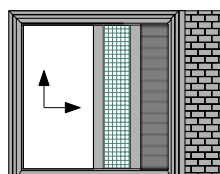

1 SASH / 1 TRACK /
FLYSCREEN / SHUTTER

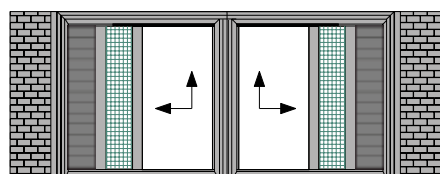

2 SASHES / 1 TRACK / FLYSCREEN / SHUTTER

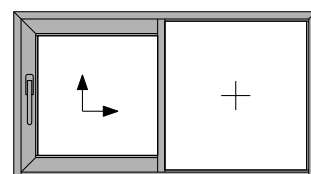

1 SASH / 1 FIXED

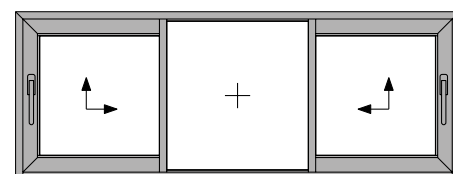

1 SASH / 1 FIXED / 1 SASH

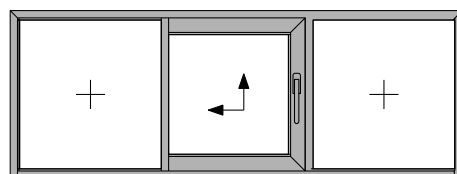

1 FIXED / 1 SASH / 1 FIXED

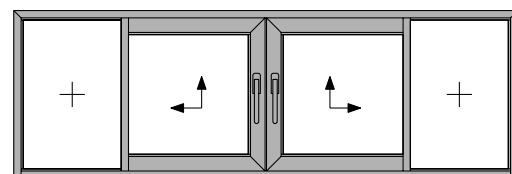

2 SASHES / 2 FIXED

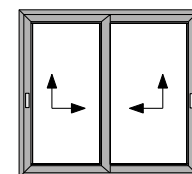

2 SASHES / 2 TRACK

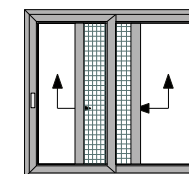

2 SASHES / 2 TRACK /
FLYSCREEN

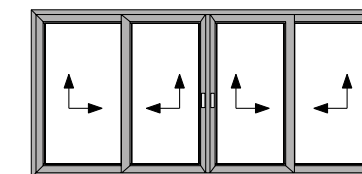

4 SASHES / 2 TRACK

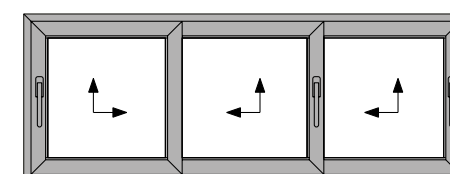

3 SASHES / 3 TRACK

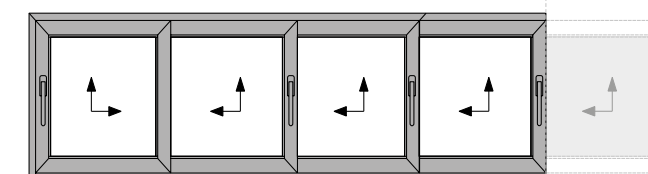







MULTI TRACK

TABLE OF PERFORMANCE

SUPREME S700

CERTIFICATION

 WATER TIGHTNESS EN 12208	1A (0 Pa)	2A (50 Pa)	3A (100 Pa)	4A (150 Pa)	5A (200 Pa)	6A (250 Pa)	7A (300 Pa)	8A (450 Pa)	9A (600 Pa)	E900 (900Pa)
 AIR PERMEABILITY EN 12207		1 (150 Pa)		2 (300 Pa)			3 (600 Pa)			4 (600 Pa)
 WIND RESISTANCE MAX TEST PRESSURE EN 12210	1 (400 Pa)		2 (800 Pa)		3 (1200 Pa)		4 (1600 Pa)		5 (2000 Pa)	
 WIND LOAD RESISTANCE TO FRONTAL DEFLECTION EN 12210	A (≤ 1/150)				B (≤ 1/200)				C (≤ 1/300)	
 SOUND REDUCTION EN 14351	41 dB									
 BURGLAR RESISTANCE EN 1627 - 1630	RC 1				RC 2				RC 3	

ALUMIL has also certified the system SUPREME S700 according to AAMA & AS standards which are available upon request







Technical approval and production conformity by the Belgian Construction Certification Association



Cradle to Cradle Certified® is the global standard for products that are safe, circular and responsibly made

SUPREME S700 ECLIPSE

CERTIFICATION

 WATER TIGHTNESS EN 12208	1A (0 Pa)	2A (50 Pa)	3A (100 Pa)	4A (150 Pa)	5A (200 Pa)	6A (250 Pa)	7A (300 Pa)	8A (450 Pa)	9A (600 Pa)	E900 (900Pa)
 AIR PERMEABILITY EN 12207		1 (150 Pa)		2 (300 Pa)			3 (600 Pa)			4 (600 Pa)
 WIND RESISTANCE MAX TEST PRESSURE EN 12210	1 (400 Pa)			2 (800 Pa)		3 (1200 Pa)		4 (1600 Pa)		5 (2000 Pa)
 WIND LOAD RESISTANCE TO FRONTAL DEFLECTION EN 12210	A (≤ 1/150)					B (≤ 1/200)				C (≤ 1/300)

THERMAL

	DIMENSIONS IN MM (w x h)	U _w in W/m ² K (U _g = 0,6)	U _w in W/m ² K (U _g = 0,8)	U _w in W/m ² K (U _g = 1,1)
2 SASHES / 2 TRACK	2600 x 2400	1,31	1,46	1,69
2 SASHES / 2 TRACK (NARROW INTERLOCKING PROFILE, LOW THRESHOLD)	2600 x 2400	1,33	1,49	1,73
4 SASHES / 2 TRACK	5200 x 2400	1,27	1,43	1,66
4 SASHES / 2 TRACK (NARROW INTERLOCKING PROFILE, LOW THRESHOLD)	5200 x 2400	1,29	1,45	1,69

Thermal performance certified according to EN ISO 10077-2

REFERENCE PROJECTS

- 1. VANCOUVER HOUSE / VANCOUVER, CANADA
- 2. PRIVATE RESIDENCE / KOS, GREECE
- 3. ALBERNI TOWER / VANCOUVER, CANADA

- 4. W DUBAI - THE PALM / DUBAI, UAE
- 5. MITSIS ALILA RESORT & SPA / RHODES, GREECE
- 6. PRIVATE RESIDENCE / TUZLA, TURKEY



1



2



3



4



5



6

www.alumil.com

**ALUMIL
HEAD OFFICES
& SHOWROOM - THESSALONIKI**

Gogousi 8, Efkarpia
Thessaloniki - GR 56429
TEL.: +30 2313011000
FAX.: +30 231692473
E-MAIL.: info@alumil.com

**ALUMIL
HEADQUARTERS**

Kilkis Industrial Area
Kilkis - GR 61100
TEL.: +30 23410 79300
FAX.: +30 23410 71988
E-MAIL.: info@alumil.com



**ALUMIL
HEAD OFFICES
& SHOWROOM - THESSALONIKI**

GOGOUSI 8, EFKARPIA
THESSALONIKI - GR 56429

TEL.: +30 2313 011000
FAX.: +30 2310 692473
EMAIL.: info@alumil.com

**ALUMIL
HEADQUARTERS**

KILKIS INDUSTRIAL AREA
KILKIS - GR 61100

TEL.: +30 23410 79300
FAX.: +30 23410 71988
EMAIL.: info@alumil.com

www.alumil.com

Alumil